

Catálogo 2026

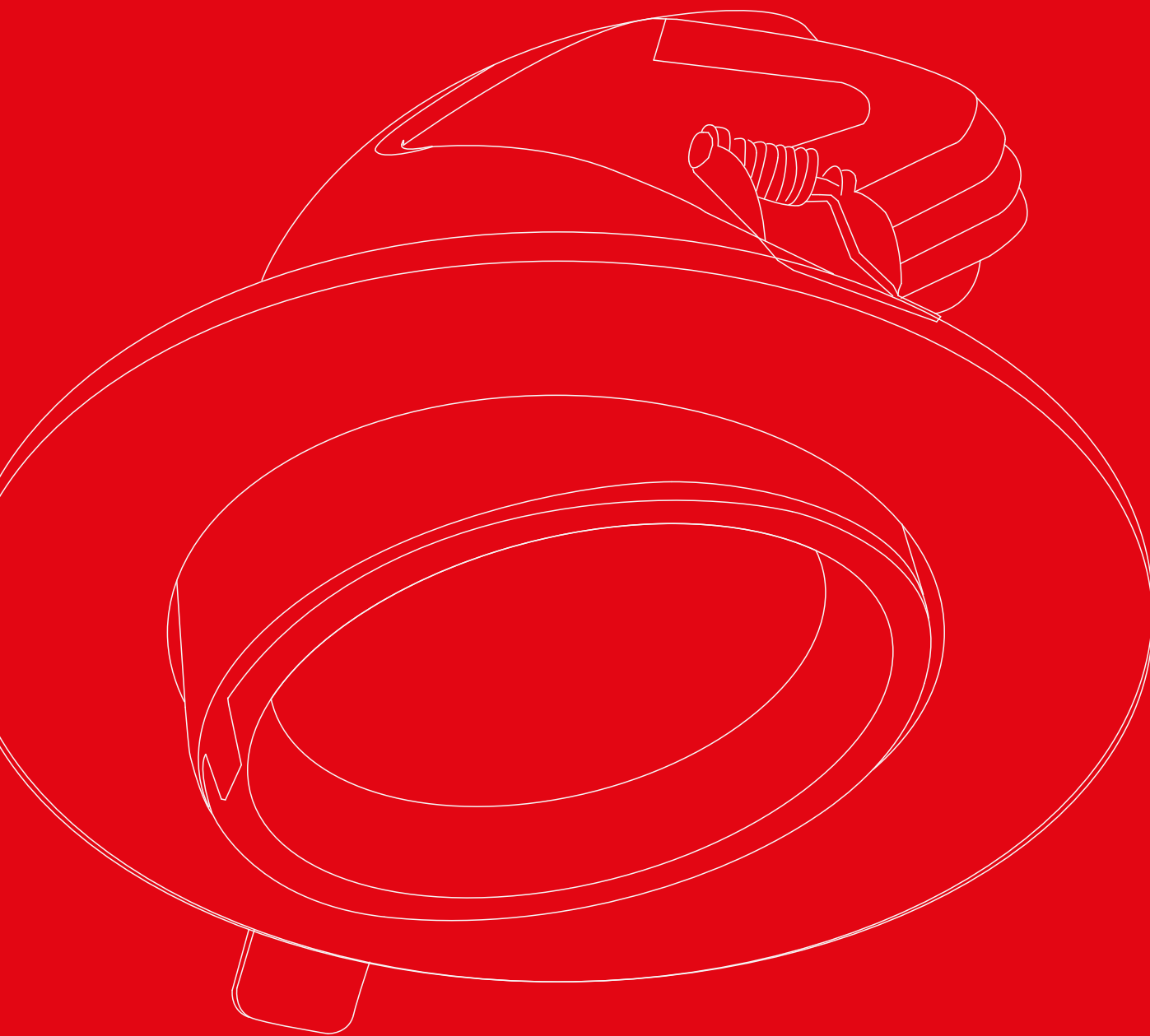

astro[®]
LED Lighting

GLOSARIO DE SÍMBOLOS



Dimeable

Indica que la luminaria permite ajustar la intensidad de la luz. Uso: Para crear ambientes más cálidos, ahorrar energía o controlar la luz según la actividad.



Switch CCT:

Indica que la luminaria permite seleccionar manualmente la temperatura de color (cálida, neutra o fría) mediante un interruptor integrado. Uso: Adaptar la luz según el ambiente deseado o la función del espacio.

TEMPERATURA DE COLOR (TC)

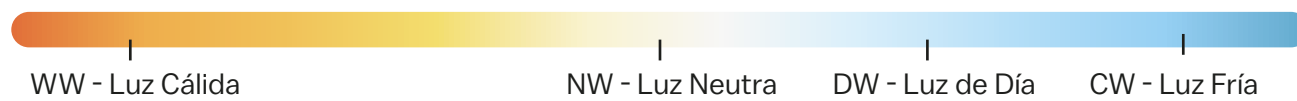

WW – Luz Cálida (2700K–3500K):

Luz amarilla que genera ambientes cálidos y confortables. Ideal para: tiendas de ropa, panaderías, fruterías. En casa: salas, comedores y recámaras.

NW – Luz Neutra (3800K–4500K):

Luz blanca equilibrada, similar a la luz natural. No altera colores ni genera ambientes cálidos o fríos. Ideal para: oficinas, pasillos y espacios generales.

DW – Luz de Día (5000K):

Luz blanca brillante, similar a un día nublado. Ofrece visibilidad neutra sin tonos cálidos ni fríos. Ideal para: estudios, talleres y espacios de concentración.

CW – Luz Fría (6000K):

Luz blanca azulada, como la de un día soleado. Aumenta la percepción de luminosidad. Ideal para: oficinas, hospitales, joyerías. En casa: cocinas y baños.

CCT (Temperatura de Color

Correlacionada):

Indica el tono de la luz blanca en grados Kelvin: cálida, neutra o fría. Algunas luminarias permiten ajustar entre estos tonos según el ambiente o uso.

RGB:

Sistema de mezcla de luz roja, verde y azul que permite crear hasta 16 millones de colores. Ideal para: efectos de luz dinámicos y decorativos.

Acero 316: aleación austenítica con molibdeno que brinda alta resistencia a la corrosión, incluso en ambientes marinos o químicos. Destaca por su durabilidad, buen desempeño en altas temperaturas y uso ideal en aplicaciones exigentes de iluminación y diseño.

NIVEL DE PROTECCIÓN

- IP20** Protección sólo para polvos, exclusivo en interiores secos.
- IP44** Protección contra sólidos >1 mm y salpicaduras de agua desde cualquier ángulo, recomendado para baños o exteriores con techo.
- IP54** Protección limitada contra polvo y salpicaduras de agua, recomendado para exteriores semicubiertos.
- IP55** Protección parcial contra polvo y chorros de agua a baja presión., recomendado para exteriores protegidos o áreas industriales ligeras.
- IP65** Hermético al polvo y resistente a chorros de agua a presión, recomendado para exteriores, terrazas, iluminación arquitectónica.
- IP66** Totalmente protegido contra polvo y chorros de agua potentes, recomendado para ambientes exigentes o expuestos a lluvia intensa.
- IP67** Hermético al polvo y sumergible en agua (hasta 1m por 30 min), recomendado para zonas húmedas, exteriores expuestos o con riesgo de inmersión temporal.
- IP68** Protección total contra polvo y sumersión continua en agua, recomendado para piscinas, fuentes, instalaciones subacuáticas.

ACABADOS

- 01 Blanco
- 02 Satinado
- 03 Gris
- 04 Grafito
- 05 Bronce Rust
- 06 Cromo
- 07 Negro
- 08 Acero
- 09 ABZ
- 10 Yeso
- 11 Concreto
- 12 Aluminio
- 14 Oro Cepillado

Nuestras luminarias incorporan LEDs de algunas de las mejores marcas del mercado.



*Nota: El color de la fotografía puede variar respecto al original debido a las limitaciones del proceso fotográfico.

ÍNDICE REFERENCIAL

- 01-08
- 09-23
- 24-28
- 29-35
- 36-57
- 58-64
- 65-81
- 82- 92
- 93-97
- 98-102
- 103-106
- 107-109
- 110-115
- 116-118
- 119-120
- 121-126
- 127-141
- 142-147

ÍNDICE NUMÉRICO

00-1218-*	08	05-6410-*	80	06-2906-*	18	6-26951-30D	37
01-30605-*	122	05-7001-*	62	06-2907-*	19	6-26957-*	37
03-2012-*	122	05-7131-*	70	06-2910-*	19	6-28151-*	37
03-4801-*	94	05-7132-*	70	06-2911-*	19	6-29012-Módulo	21
03-4901-*	95	05-7302-*	69	06-3106-*	17	6-51112-*	22
03-9003-*	95	05-7491-*	68	06-3108-*	33	6-52112-*	22
03-9005-GU-*	95	05-7492-*	68	06-3108-D	33	6-53112-*	22
03-9101-E2-*	95	05-7493-*	67	06-3110-*	33	07-0061-*	88
04-1202-*	01	05-7494-*	67	06-3110-D	33	07-0062-*	88
04-1215-*	01	05-7510-*	77	06-3117-*	33	07-0301-*	85
05-0010-*	105	05-8054-*	68	06-3117-D	33	07-0301-RGB	111
05-0020-*	105	05-8107-*	73	06-3123-*	17	07-1011-*	89
05-0030-*	105	05-8238-*	81	06-3124-*	17	07-1012-*	89
05-0050-*	105	05-9001-*	61	06-3125-*	33	07-1014-*	89
05-0093-*	72	05-9006-*	70	06-3155-*	14	07-1015-*	84
05-0094-*	72	05-9105-*	94	06-3198-*	14	07-1276-*	60
05-0301-*	75	05-9106-*	94	06-3199-*	16	07-1280-*	62
05-0302-*	75	05-9205-*	94	06-3206-*	17	07-1701-*	83
05-0304-*	75	05-9801-*	73	06-3207-*	17	07-1701-RGB	111
05-0502-RGB	113	5-21101-*	115	06-3208-*	17	07-1707	108
05-0901-RGB	111	5-21201-*	115	06-3210-*	11	07-2721-*	83
05-1001-*	80	5-21301-*	104	06-3211-*	12	07-4051-*	109
05-1018-*	74	5-25100-*	106	06-3212-*	12	07-4201-*	62
05-1241-*	71	5-25250-*	106	06-3213-*	12	07-6201-*	86
05-1248-*	71	5-25400-*	106	06-3254-*	14	07-6201-10*	86
05-2016-*	122	5-3620-RGB-*	114	06-3901*	20	07-62024*	109
05-2061-*	77	5-3650-RGB-*	114	06-3902*	20	07-6301-*	86
05-2071-*	79	5-36100-RGB-*	114	06-3903*	20	07-6301-10*	86
05-2072-*	79	5-36150-RGB-*	114	06-4401-*	16	07-6301-RGB	112
05-2091-*	74	06-0113-*	32	06-4402-*	16	07-6401-*	87
05-2101-*	71	06-0114-*	32	06-6313-*	31	07-6401-10-*	87
05-2102-*	71	06-0305-*	35	06-7010-*	40	07-6401-RGB	112
05-2121-*	78	06-0321-*	10	06-7091-*	39	07-7053-*	83
05-2143-*	74	06-0322-*	10	06-7092-*	39	07-07300-*	92
05-2271-*	76	06-0323-*	10	06-7093-*	39	07-7301-*	87
05-2509-*	76	06-0325-*	10	06-7095-*	39	07-07601-*	92
05-2551-*	81	06-0326-*	11	06-8007-*	38	07-9201-*	85
05-2552-*	81	06-0329-*	11	06-8012-*	38	07-30011-*	91
05-2616-*	77	06-0353-*	13	06-8318-*	38	07-30012-*	91
05-2678-*	80	06-0357-*	13	06-8325-*	38	07-30016-*	91
05-2701-*	73	06-0361-*	13	06-9033-*	30	07-30100-*	85
05-2799-*	59	06-0370-*	11	06-9034-*	30	07-40921-*	90
05-2805-*	59	06-0409-*	35	06-9035-*	30	07-40922-*	90
05-2800-*	59	06-0512-*	35	06-9129-*	27	07-40926-*	90
05-2806-*	59	06-0718-*	35	06-9130-*	27	07-62024-*	109
05-2801-*	59	06-1070-*	32	06-9131-*	27	07-62100-*	84
05-2807-*	59	06-1090-*	32	06-9132-*	27	08-1273-*	60
05-2921-*	74	06-1224-*	35	06-9224-*	26	08-1901-*	63
05-2942-*	81	06-1414-*	34	06-9229-*	27	08-2201-*	63
05-3223-*	76	06-2011-*	53	06-9285-*	26	08-2203-*	63
05-3500-*	106	06-2012-*	31	06-9442-*	26	08-3013-*	26
05-3505-*	97	06-2283-*	15	06-9703-*	28	08-7401-*	60
05-4030-*	66	06-2314-*	31	06-9703-D	28	08-7501-*	60
05-4031-*	66	06-2315-*	31	06-9703-I	28	08-8301-*	64
05-4033-*	66	06-2489-*	15	06-9703-TD	28	08-8401-*	64
05-4820-*	79	06-2751-*	37	06-9703-TI	28	08-8501-*	64
05-5031-*	69	06-2901-*	18	6-12554-*	23	08-9002-*	61
05-5032-*	69	06-2904-*	18	6-12654-*	23	08-9245-*	64
05-6216-*	80	06-2905-*	18	6-26951-*	37	10-1071-*	99

ÍNDICE NUMÉRICO

10-1932-*	100	23-1300-*	56	80-0207-*	05	FS-48356-TC	131
10-2091-*	101	23-2123-*	78	80-0903-*	01	FS-96555-RGBW	132
10-2103-*	102	23-2815-*	44	80-0924-*	01	FV-27286-*	139
10-2122-*	97	23-2825-*	44	80-1015-*	06	FV-48110-*	140
10-2351-*	96	25-6215-*	126	80-1112-*	22	FV-48120-*	139
10-2352-*	96	25-6240-*	126	80-1205-*	02	HD06VCRH 7B	116
10-2492-*	97	26-1340-50	57	80-2003-*	06	LCH-1165-68-T3PA	142
10-2522-*	101	26-6640-40	57	80-2006-*	02	LCH-1165-68-T5P	142
10-2531-*	96	26-6640-50	57	80-2007-*	02	LCH-1312-68-3P	142
10-2553-*	96	26-6640-CCT	57	80-2225-*	02	LCH-1312-68-4P	142
10-2704-*	99	26-6675-40	57	80-3002-*	06	LT-CG-SPI	134
10-3341-*	122	26-6675-50	57	81-0925-*	01	M-TRA100-*	47
10-4010-*	125	27-4001-40	117	90-2501-RGB	113	M-TRA200-*	47
10-4801-*	97	30-0007-*	50	90-2943-*	104	PS-12025-*	143
11-1735-*	42	30-0010-*	51	90-3001-*	104	PS-12050-*	143
11-2409-*	41	30-0012-*	50	90-3001-RGB	113	PS-12100-*	143
11-2815-*	43	30-0024-*	48	90-3201-*	104	PS-12100-D	145
11-2825-*	43	30-0048-*	48	90-3202-*	104	PS-12150-*	144
11-3001-*	42	30-0054-*	49	97-06300-*	92	PS-12150-D	143
11-3202-*	13	30-0055-*	49	97-06601-*	92	PS-12250-*	144
11-5009-*	42	30-0300-*	48	AP-1510-2-*	141	PS-12250-D	145
12-2815-*	43	30-0500-*	50	AP-1616-2-*	141	PS-24050-*	143
12-2825-*	43	30-0510-*	51	AP-2011-2-*	141	PS-24100-*	143
15-0050-65	120	30-0520-*	51	AP-2013-2-*	141	PS-24100-D	145
15-0100-65	120	30-0600-*	48	AP-2507-2-*	141	PS-24150-*	144
15-0150-65	120	30-0811-*	49	AP-2811-2-*	141	PS-24150-D	145
20-1150-3TC	118	30-1000-*	50	C-001-*	47	PS-24250-*	144
20-3110-*	118	30-2307-*	49	C-002L-*	47	PS-24250-D	145
20-9080-40/65	118	30-2308-*	51	C-003T-*	47	PS-24400-*	144
22-0210-*	117	35-1005-*	03	C-004C-*	47	RF-8124	131
22-0218-*	117	35-2703-*	04	C-005P-*	47	SP105E	134
22-1130-*	55	40-2015-*	124	CBL-3005-*	52	TH-100-*	47
22-1216-*	54	40-2104-*	123	CON-221232-*	54	TH-200-*	47
22-1220-*	52	40-2115-*	123	CON-3005-*	52	TR-0310-*	45
22-1232-*	54	40-2303-*	124	CON-B2-*	46	TRA-0812-*	146
22-2060-*	53	40-2306-*	124	CON-F6	46	TRA-1245-*	146
22-2073-*	79	40-2608-*	125	CON-I1-*	46	TRA-1250-*	146
22-2409-*	41	45-1004-*	03	CON-L3-*	46	TRA-12100-*	147
22-2409-*	41	45-1204-*	04	CON-T4-*	46	TRA-12200-*	147
22-2815-*	44	45-2604-*	04	CON-X5-*	46	TRA-2430-*	146
22-2825-*	44	50-0070-*	102	CONL-221232-*	54	TRA-2460-*	146
22-3002-*	42	52-4020-*	124	CONT-221232-*	54	TRA-24100-*	147
22-3005-*	52	55-1933-*	100	CONX-221232-*	54	TRA-24200-*	147
22-3204-*	13	55-2091-*	101	Control HD05R	116	TR-0320-*	45
22-4032-*	66	55-2704-*	99	FB-43282-*	128	XR-361L-*	45
22-5031-*	69	55-2773-*	102	FB-43528-*	135	XR-361R-*	45
22-6010-*	52	55-4021-RGBW	115	FB-43528-CCT	135	XR-0362-*	45
22-6136-*	53	55-9107-*	99	FB-72282-*	128	XR-363L-*	45
22-6503-*	41	60-1007-*	03	FC-43286-*	136	XR-363R-*	45
22-6504-*	41	60-1011-*	03	FE-43287-*	129	XR-0364LL-*	45
22-7093-*	40	64-2706-*	04	FE-72287-*	129	XR-0364LR-*	45
22-7095-*	40	66-3407-*	15	FP-28119-*	133	XR-0364RL-*	45
22-7133-*	70	77-0306-*	109	FP-28186-RGB	134	XR-0364RR-*	45
22-7161-*	67	77-0391-*	109	FS-0036-RGB	132	XR-0365-*	45
22-8401-*	07	77-0393-RGB	111	FS-1036-RGB	136	XR-0366-*	45
22-8402-*	07	77-4703-*	108	FS-27140-*	138	XR-0367-*	45
22-8403-*	07	77-4703-RGB*	113	FS-27140-CL	138	XR-369L-*	45
22-8404-*	07	77-6013-RGB	112	FS-27352-*	140	XR-369R-*	45
22-9036-*	30	77-6015-RGB	112	FS-43285-*	130		
22-9051-*	68						

FOCOS LED



FOCOS LED



04-1202-*

Watts: 1.5W
 Base: G4
 Lúmenes: 180lm
 TC: 3000K
 Voltaje: 12V
 CRI: >80
 IP: 20
 Ángulo Apertura: 360°
 Material: Tapa de Gel

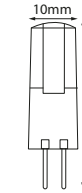

04-1215-*

Watts: 1W
 Base: G4
 Lúmenes: 120lm
 TC: 3000K
 Voltaje: 12V
 CRI: >80
 IP: 20
 Ángulo Apertura: 360°
 Material: Cerámica + Cristal

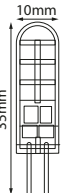

80-0924-*

Watts: 3.5W
 Base: G9
 Lúmenes: 380lm
 TC: 3000K | 4000K
 Voltaje: 127V
 CRI: >80
 IP: 20
 Ángulo Apertura: 360°
 Material: Cerámica + PC

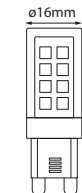

81-0925-*

Watts: 4W
 Base: G9
 Lúmenes: 500lm
 TC: 3000K
 Atenuable: Si
 Voltaje: 127V
 CRI: >80
 IP: 20
 Ángulo Apertura: 360°
 Material: Cerámica + PC

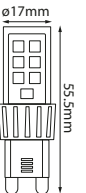

80-0903-*

Watts: 4W
 Base: G9
 Lúmenes: 360lm
 TC: 3000K | 4000K
 Voltaje: 127V
 CRI: >80
 IP: 20
 Ángulo Apertura: 90°
 Material: Cerámica + PC

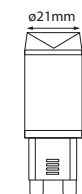

FOCOS LED



80-1205-*

Watts: 6W
 Base: GU5.3
 Lúmenes: 510lm
 TC: 3000K | 4000K
 Voltaje: 100-240V
 CRI: >80
 IP: 20
 Ángulo Apertura: 38°
 Material: Aluminio + PC

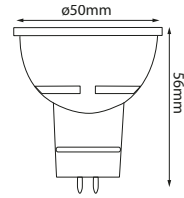

80-2006-*

Watts: 7W
 Base: GU10
 Lúmenes: 560lm
 TC: 3000K | 4000K
 Voltaje: 110-130V
 CRI: >80
 IP: 20
 Ángulo Apertura: 38°
 Material: Aluminio + PC

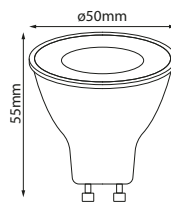

35-1005-*

Watts: 5.5W
 Base: E27
 Lúmenes: 470lm
 TC: 3000K | 4000K
 Voltaje: 110-130V
 CRI: >80
 IP: 20
 Ángulo Apertura: 270°
 Material: Aluminio + PC

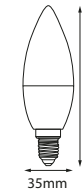

45-1004-*

Watts: 5.5W
 Base: E27
 Lúmenes: 470lm
 TC: 3000K | 4000K | 6000K
 Voltaje: 110-130V
 CRI: >80
 IP: 20
 Ángulo Apertura: 270°
 Material: Aluminio + PC

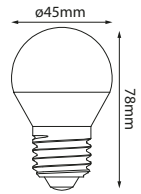

80-2007-*

Watts: 5.5W
 Base: GU10
 Lúmenes: 550lm
 TC: 3000K | 4000K
 Voltaje: 90-130V
 CRI: >80
 IP: 20
 Ángulo Apertura: 35°
 Material: Aluminio + PC

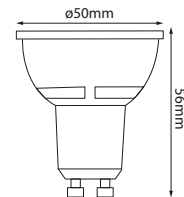

80-2225-*

Watts: 5W
 Base: GU10
 Lúmenes: 400lm
 TC: 2700K | 3000K | 4100K | 6500K
 Voltaje: 100-240V
 CRI: >80
 IP: 20
 Ángulo Apertura: 38°
 Material: Aluminio + PC

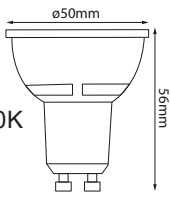

60-1007-*

Watts: 7W
 Base: E26
 Lúmenes: 550lm
 TC: 3000K | 4000K | 6000K
 Voltaje: 110-130V
 CRI: >80
 IP: 20
 Ángulo Apertura: 270°
 Material: Aluminio + PC

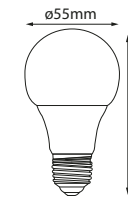

60-1011-*

Watts: 11W
 Base: E26
 Lúmenes: 950lm
 TC: 3000K | 4000K | 6000K
 Voltaje: 110-130V
 CRI: >80
 IP: 20
 Ángulo Apertura: 270°
 Material: Aluminio + PC

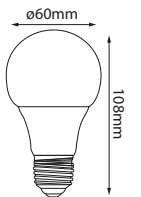

FOCO LED



35-2703-*

Watts: 5W
 Base: E12
 Lúmenes: 600lm
 TC: 2700K
 Voltaje: 110-130V
 CRI: >80
 IP: 20
 Ángulo Apertura: 360°
 Material: Aluminio + Cristal

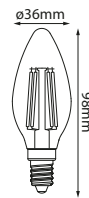

45-1204-*

Watts: 5W
 Base: E12
 Lúmenes: 600lm
 TC: 2700K
 Voltaje: 110-130V
 CRI: >80
 IP: 20
 Ángulo Apertura: 360°
 Material: Aluminio + Cristal

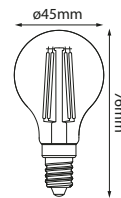

80-0207-*

Watts: 7W
 Base: E26 / PAR20
 Lúmenes: 560lm
 TC: 3000K | 4000K
 Voltaje: 85-265V
 CRI: >80
 IP: 65
 Ángulo Apertura: 40°
 Material: Cristal

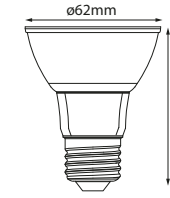

45-2604-*

Watts: 5W
 Base: E26
 Lúmenes: 600lm
 TC: 2700K
 Voltaje: 110-130V
 CRI: >80
 IP: 20
 Ángulo Apertura: 360°
 Material: Aluminio + Cristal

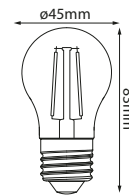

64-2706-*

Watts: 5W
 Base: E26
 Lúmenes: 600lm
 TC: 2700K
 Voltaje: 110-130V
 CRI: >80
 IP: 20
 Ángulo Apertura: 360°
 Material: Aluminio + Cristal

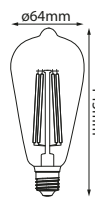

FOCOS LED

FOCOS LED



80-2003-*

Watts: 9W
 Base: E26 / PAR20
 Lúmenes: 720lm
 TC: 3000K
 Voltaje: 110-240V
 CRI: >80
 IP: 20
 Ángulo Apertura: 38°
 Material: Plástico

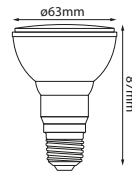

80-3002-*

Watts: 10W
 Base: E26 / PAR30
 Lúmenes: 800lm
 TC: 3000K
 Voltaje: 85-265V
 CRI: >80
 IP: 20
 Ángulo Apertura: 45°
 Material: Aluminio + PC

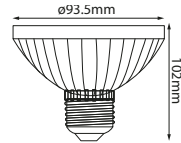

80-1015-*

Watts: 12W
 Base: G53 / AR111
 Lúmenes: 1200lm
 TC: 3000K
 Voltaje: 12V AC/DC
 CRI: >80
 IP: 20
 Ángulo Apertura: 20°
 Material: Aluminio + PC

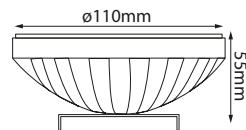

INTELETUB



22-8401-*

Watts: 18W
 Lúmenes: 1800lm
 TC: 3000K | 4000K
 Voltaje: 100-240V
 CRI: >80
 IP: 20
 Ángulo Apertura: 120°
 Material: Plástico
 *Interconectable hasta 8 piezas

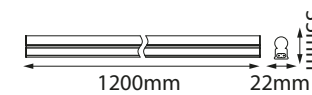

22-8402-*

Watts: 9W
 Lúmenes: 900lm
 TC: 3000K | 4000K
 Voltaje: 100-240V
 CRI: >80
 IP: 20
 Ángulo Apertura: 120°
 Material: Plástico
 *Interconectable hasta 8 piezas

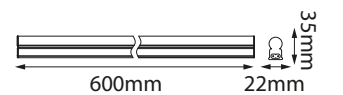

22-8403-*

Watts: 12W
 Lúmenes: 1200lm
 TC: 3000K | 4000K
 Voltaje: 100-240V
 CRI: >80
 IP: 20
 Ángulo Apertura: 120°
 Material: Plástico
 *Interconectable hasta 8 piezas

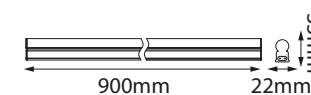

22-8404-*

Watts: 5W
 Lúmenes: 900lm
 TC: 3000K | 4000K
 Voltaje: 100-240V
 CRI: >80
 IP: 20
 Ángulo Apertura: 120°
 Material: Plástico
 *Interconectable hasta 8 piezas

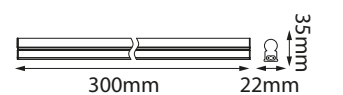

Accesorios



CON-22840

*Incluidos



CON-840



CON-15840

*Se vende por separado



CBL-22840

TUBO LED

00-1218-*

- Watts: 18W
- Base: G13
- Lúmenes: 1620lm
- TC: 3000K | 4100K | 6000K
- Voltaje: 100-240V
- CRI: >80
- IP: 20
- Ángulo Apertura: 270°
- Material: Cristal

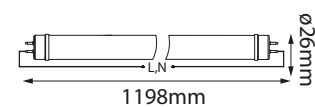

BASIC



LEO



06-0321-*

Base: GU10
IP: 20
Material: PC

-01 Blanco -07 Negro

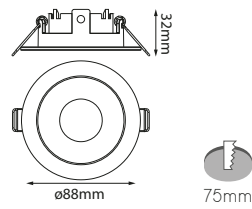

06-0322-*

Base: GU10
IP: 20
Material: PC

-01 Blanco -07 Negro

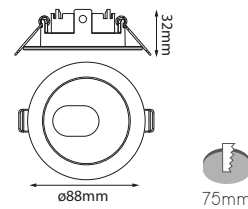

06-0326-*

Base: GU10
IP: 20
Material: PC

-01 Blanco -07 Negro

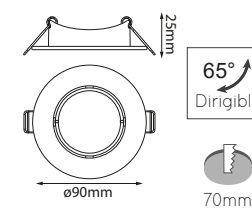

06-0329-*

Base: GU10
IP: 20
Material: PC

-01 Blanco -07 Negro

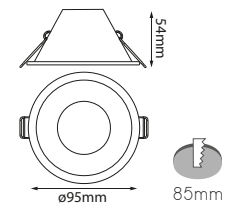

06-0323-*

Base: GU10
IP: 20
Material: PC

-01 Blanco -07 Negro

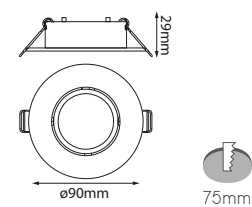

06-0325-*

Base: GU10
IP: 20
Material: PC

-01 Blanco -07 Negro

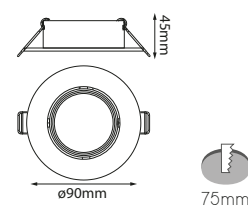

06-3210-*

Base: GU10
IP: 20
Material: PC

-01 Blanco -07 Negro

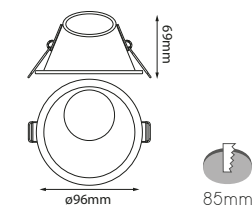

06-0370-*

Base: GU10
IP: 65
Material: PC

-01 Blanco -07 Negro

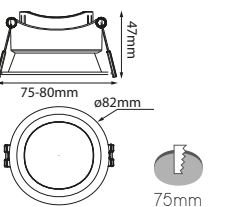

*NOTA: Soquet incluido. Foco se vende por separado

LEO

*NOTA: Soquet incluido. Foco se vende por separado

LEO



06-3211-*

Base: GU10
IP: 20
Material: PC

-01 Blanco -07 Negro

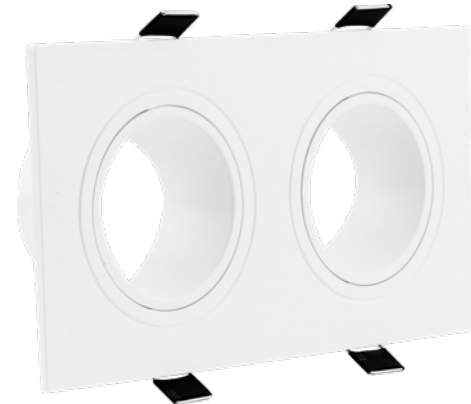
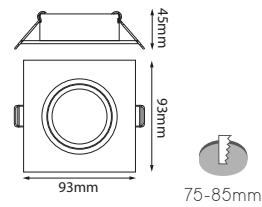

06-3212-*

Base: 2*GU10
IP: 20
Material: PC

-01 Blanco -07 Negro

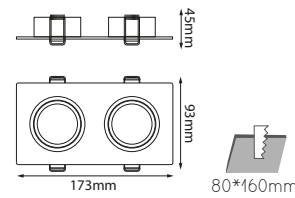

06-3213-*

Base: 3*GU10
IP: 20
Material: PC

-01 Blanco -07 Negro

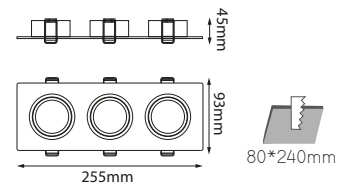

06-0353-*

Base: GU10
IP: 20
Material: PC

-01 Blanco -07 Negro

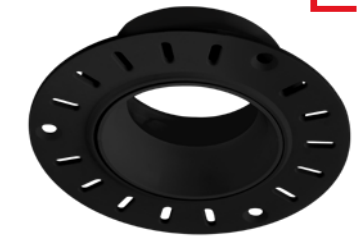
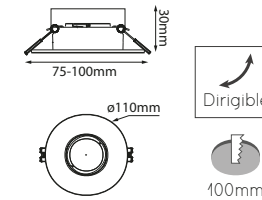

06-0357-*

Base: GU10
IP: 20
Material: PC

-01 Blanco -07 Negro

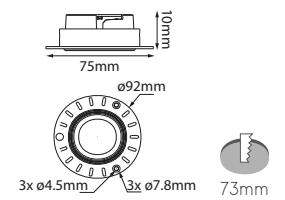

06-0361-*

Base: GU10
IP: 20
Material: PC

-01 Blanco -07 Negro

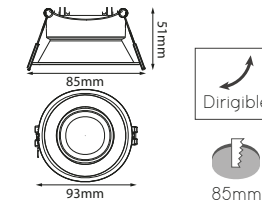

11-3202-*

Base: GU10
IP: 20
Material: PC

-01 Blanco -07 Negro

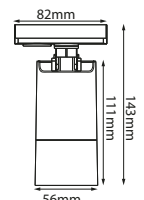

22-3204-*

Base: GU10
IP: 20
Material: PC

-01 Blanco -07 Negro

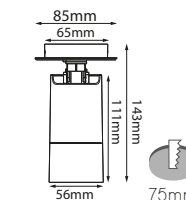

¡Dos tipos de instalación!
Empotrado y a canope

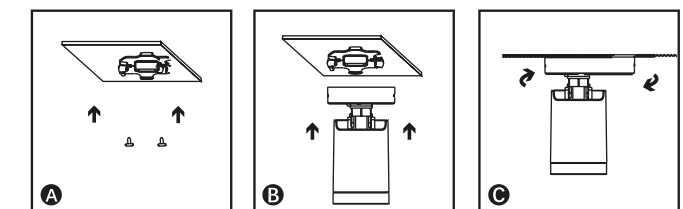

*NOTA: Soquet incluido. Foco se vende por separado

*NOTA: Soquet incluido. Foco se vende por separado

BASIC



06-3155-*

Base: GU10
IP: 20
Material: Aluminio

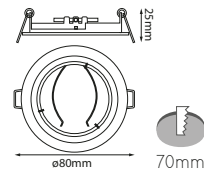

-01 Blanco -02 Satinado -07 Negro



06-3254-*

Base: GU10
IP: 20
Material: Aluminio

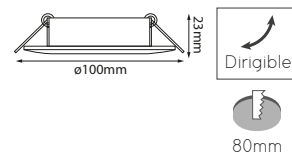

-01 Blanco -02 Satinado -07 Negro



06-2283-*

Base: GU10
IP: 20
Material: Aluminio

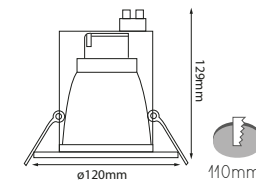

-01 Blanco -02 Satinado



06-3198-*

Base: GU10
IP: 20
Material: Aluminio

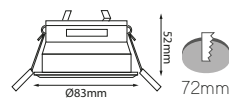

-01 Blanco -07 Negro



06-2489-*

Base: G53 / AR111
IP: 20
Material: Aluminio

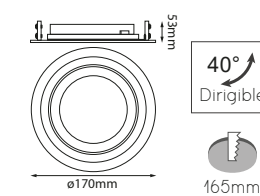

-01 Blanco



66-3407-*

Base: GU10
IP: 65
Material: Aluminio

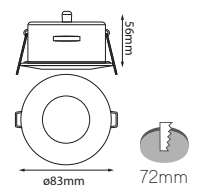

-01 Blanco -06 Cromo

*NOTA: Soquet incluido. Foco se vende por separado

*NOTA: Soquet incluido. Foco se vende por separado

BASIC



06-3199-*

Base: GU10
IP: 20
Material: Aluminio

-01 Blanco -07 Negro

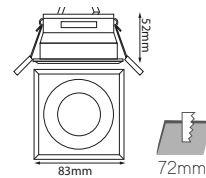

06-4401-*

Base: GU10
IP: 20
Material: Aluminio

-01 Blanco

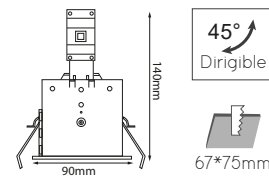

06-4402-*

Base: GU10
IP: 20
Material: Aluminio

-01 Blanco -03 Gris

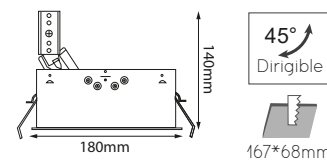

06-3106-*

Base: GU10
IP: 20
Material: Aluminio

-01 Blanco -07 Negro

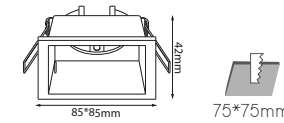

06-3206-*

Base: 2*GU10
IP: 20
Material: Aluminio

-01 Blanco -07 Negro

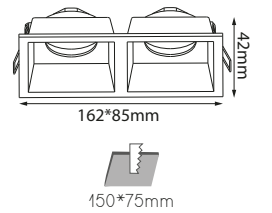

06-3207-*

Base: GU10
IP: 20
Material: Aluminio

-01 Blanco -07 Negro

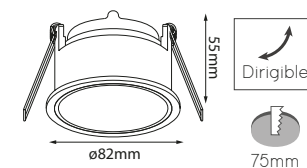

06-3208-*

Base: GU10
IP: 20
Material: Aluminio

-01 Blanco -07 Negro

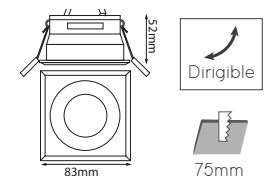

06-3123-*

Base: GU10
IP: 20
Material: Aluminio

-01 Blanco

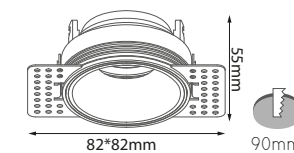

06-3124-*

Base: 2*GU10
IP: 20
Material: Aluminio

-01 Blanco

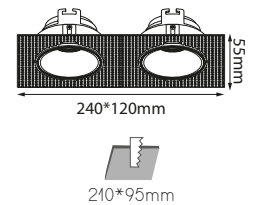

*NOTA: Soquet incluido. Foco se vende por separado

CENTURIÓN

*NOTA: Soquet incluido. Foco se vende por separado

NOX



06-2901-*

Base: GU10
IP: 20
Material: Aluminio

-01 Blanco -07 Negro

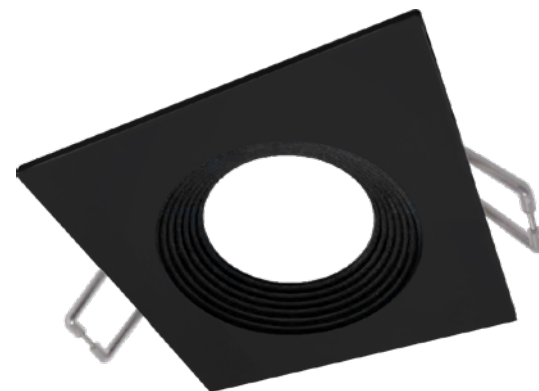
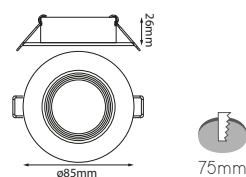

06-2904-*

Base: GU10
IP: 20
Material: Aluminio

-01 Blanco -07 Negro

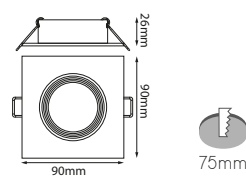

06-2907-*

Base: GU10
IP: 20
Material: Aluminio

-01 Blanco -07 Negro

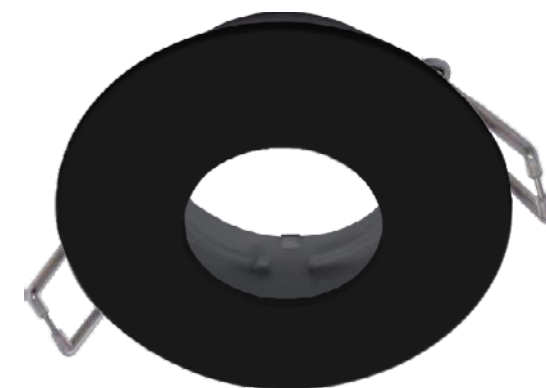
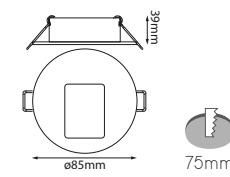

06-2910-*

Base: GU10
IP: 20
Material: Aluminio

-01 Blanco -07 Negro

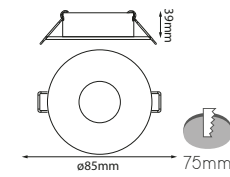

06-2905-*

Base: GU10
IP: 20
Material: Aluminio

-01 Blanco -07 Negro

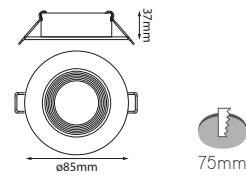

06-2906-*

Base: GU10
IP: 20
Material: Aluminio

-01 Blanco -07 Negro

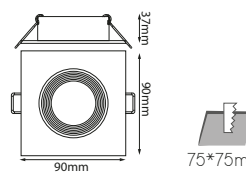

06-2911-*

Base: GU10
IP: 20
Material: Aluminio

-01 Blanco -07 Negro

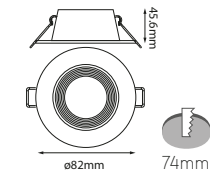

*NOTA: Soquet se vende por separado SQT-GU10

NOX

*NOTA: Soquet se vende por separado SQT-GU10

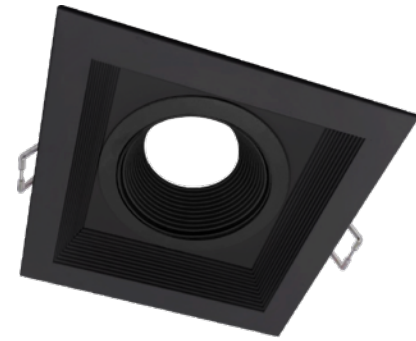

06-3901*

Base: GU10
IP: 20
Material: Aluminio

01 Blanco 07 Negro

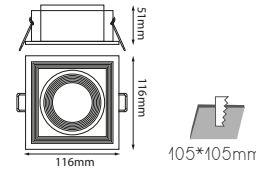

06-3902*

Base: 2*GU10
IP: 20
Material: Aluminio

01 Blanco 07 Negro

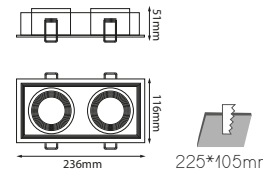

06-3903*

Base: 3*GU10
IP: 20
Material: Aluminio

01 Blanco 07 Negro

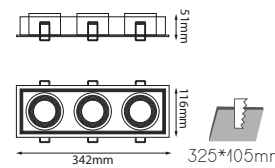

*NOTA: Soquet se vende por separado SQT-GU10

Sugerencias de Uso NOX

Opción 1: FOCO + Soquet

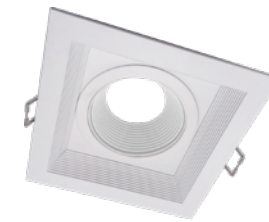

Downlight
Serie NOX

+

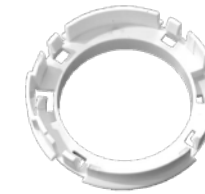

ARO-2912
Incluido

+



Foco GU10
Se vende por separado

+



SQT-GU10
Se vende por separado

*NOTA: Retirar ARO-2912 si va a usar Módulo LED

Opción 2: Módulo de LED 12W Dimeable

6-29012-Módulo



+



Downlight
Serie NOX

Módulo de LED 12W Disponible



6-29012-Módulo

Watts: 12W
Lúmenes: 1100lm
TC: 3000K | 4000K
Voltaje: 127V
CRI: >80
IP: 20
Ángulo Apertura: 30°



06-2906-01 + Módulo LED



06-2907-01 + Módulo LED



06-2910-01 + Módulo LED

HELIOS



6-5112-*

Watts: 12W
 Lúmenes: 960lm
 TC: 3000K | 4000K
 Voltaje: 90-240V
 CRI: >80
 IP: 20
 Ángulo Apertura: 20°
 Material: Aluminio + PMMA

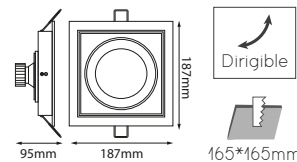

01 Blanco 07 Negro



6-5212-*

Watts: 2*12W
 Lúmenes: 1920lm
 TC: 3000K | 4000K
 Voltaje: 90-240V
 CRI: >80
 IP: 20
 Ángulo Apertura: 20°
 Material: Aluminio + PMMA

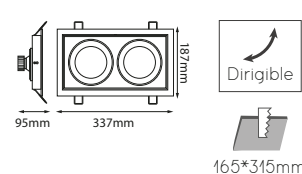

01 Blanco 07 Negro

APOLO



6-12554-*

Watts: 2*9W
 Lúmenes: 1200lm
 TC: 3000K | 4000K
 Voltaje: 90-130V
 CRI: >80
 IP: 20
 Ángulo Apertura: 24°
 Material: Aluminio

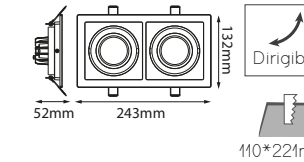

01 Blanco 07 Negro



6-5312-*

Watts: 3*12W
 Lúmenes: 2880lm
 TC: 3000K | 4000K
 Voltaje: 90-240V
 CRI: >80
 IP: 20
 Ángulo Apertura: 20°
 Material: Aluminio + PMMA

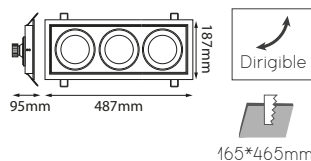

01 Blanco 07 Negro



80-1112*

Watts: 12W
 Lúmenes: 960lm
 TC: 3000K
 Voltaje: 90-240V
 CRI: >80
 IP: 20
 Ángulo Apertura: 20°
 Material: Aluminio

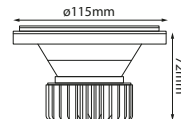

6-12654-*

Watts: 3*9W
 Lúmenes: 1800lm
 TC: 3000K | 4000K
 Voltaje: 90-130V
 CRI: >80
 IP: 20
 Ángulo Apertura: 24°
 Material: Aluminio

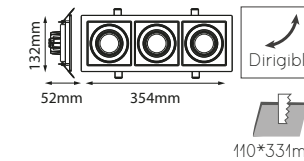

01 Blanco 07 Negro

*NOTA: Focos incluidos. Opción de foco dimeable 80-1112-D *Se vende por separado

* Accesorio dimmer ACT-26752-D se vende por separado

GYPSUM



Luminarios fabricados en yeso, especialmente diseñados para instalarse en plafones de tablaroca. Su acabado invisible se integra perfectamente al entorno, enriqueciendo la atmósfera de cualquier espacio.

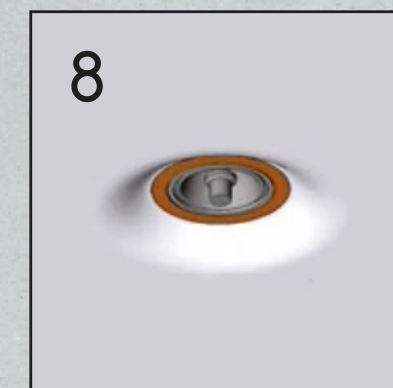
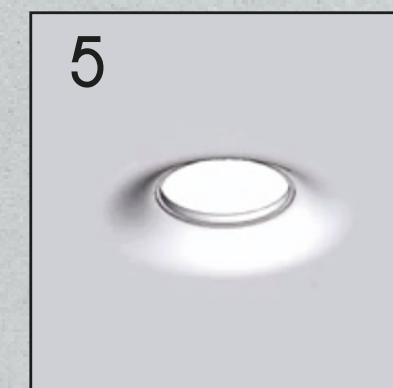
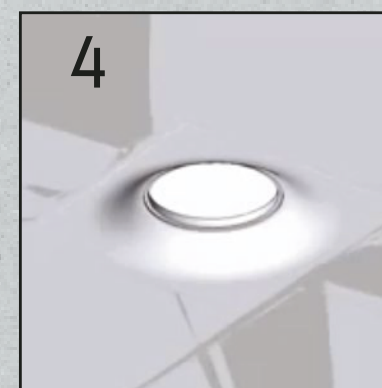
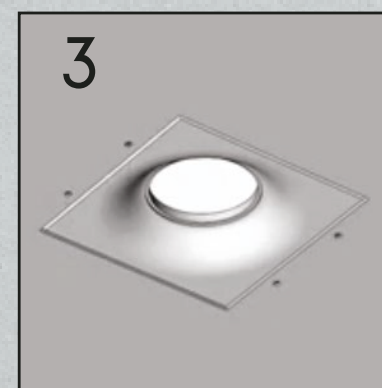
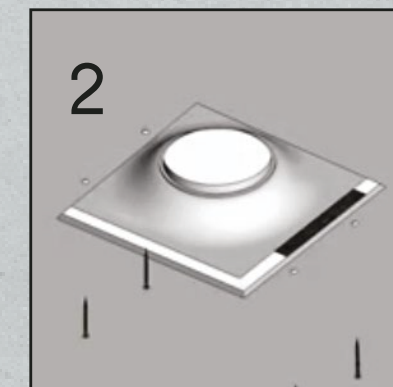
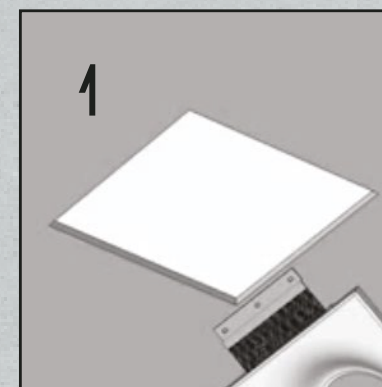

GYPSUM

**06-9224-***

Base: GU10
IP: 20
Material: Yeso
*Socket incluido

-10 Yeso

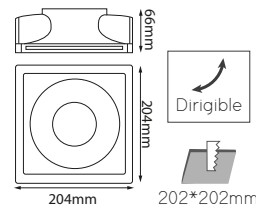
**06-9285-***

Base: GU10
IP: 20
Material: Yeso
*Socket incluido

-10 Yeso

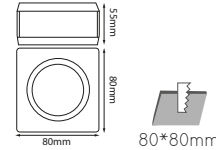
**06-9129-***

Base: GU10
IP: 20
Material: Yeso
*Socket incluido

-10 Yeso

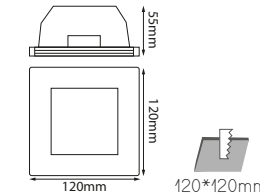
**06-9130-***

Base: GU10
IP: 20
Material: Yeso
*Socket incluido

-10 Yeso

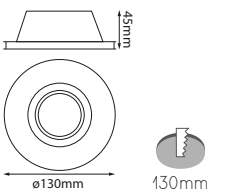
**06-9442-***

Base: AR111
IP: 20
Material: Yeso
*Socket incluido

-10 Yeso

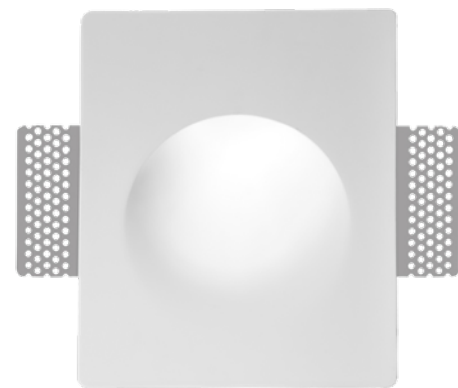
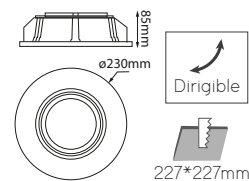
**08-3013-***

Base: GU10
IP: 20
Material: Yeso
*Socket incluido

-10 Yeso

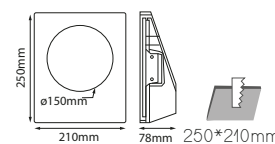
**06-9131-***

Base: GU10
IP: 20
Material: Yeso
*Socket incluido

-10 Yeso

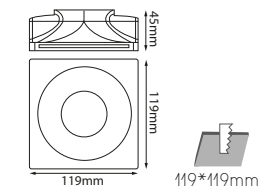
**06-9132-***

Base: GU10
IP: 20
Material: Yeso
*Socket incluido

-10 Yeso

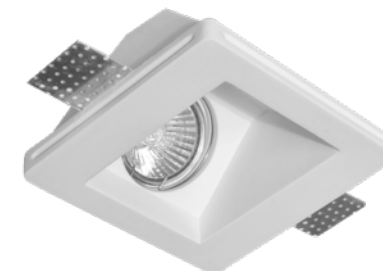
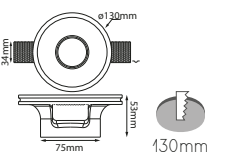
**06-9229-***

Base: GU10
IP: 20
Material: Yeso
*Socket incluido

-10 Yeso

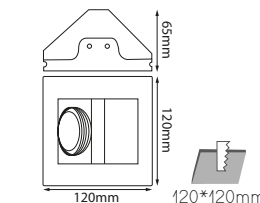

*NOTA: Soquet incluido. Foco se vende por separado

*NOTA: Soquet incluido. Foco se vende por separado

GYPSUM

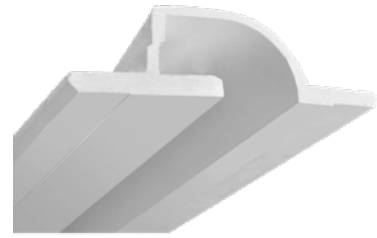

06-9703-*

Base: Tira LED
IP: 20
Material: Yeso

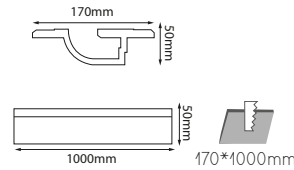

-10 Yeso



06-9703-D

Base: Tira LED
IP: 20
Material: Yeso

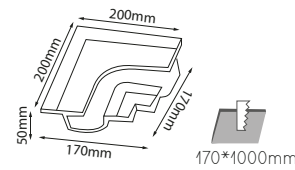

-10 Yeso



06-9703-I

Base: Tira LED
IP: 20
Material: Yeso

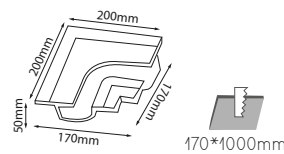

-10 Yeso



06-9703-TD

Base: Tira LED
IP: 20
Material: Yeso

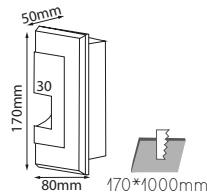

-10 Yeso



06-9703-TI

Base: Tira LED
IP: 20
Material: Yeso

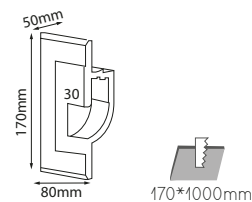

-10 Yeso

*NOTA: Tira LED se vende por separado

DOWNLIGHTS



CÍCLOPE



06-9033-*

Watts: 11W
 Lúmenes: 880lm
 TC: 3000K
 Voltaje: 100-240V
 CRI: >80
 IP: 20
 Ángulo Apertura: 40°
 Material: Yeso

-10 Yeso

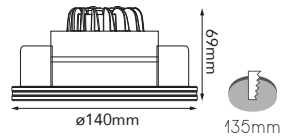

06-9034-*

Watts: 11W
 Lúmenes: 880lm
 TC: 3000K
 Voltaje: 100-240V
 CRI: >80
 IP: 20
 Ángulo Apertura: 38°
 Material: Aluminio

-01 Blanco

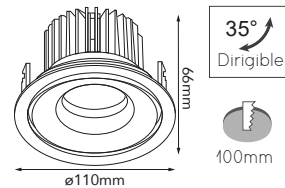

CORAL | QUARK | MARS



06-2012-*

Watts: 1W
 Lúmenes: 80lm
 TC: 3000K | 4000K
 Voltaje: 127V
 CRI: >80
 IP: 20
 Ángulo Apertura: 40°
 Material: Aluminio

-01 Blanco -02 Satinado

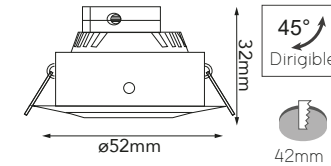

*Driver remoto incluido



06-2314-*

Watts: 10W
 Lúmenes: 660lm
 TC: 3000K
 Voltaje: 90-130V
 CRI: >85
 IP: 20
 Ángulo Apertura: 24°
 Material: Aluminio

-01 Blanco -07 Negro

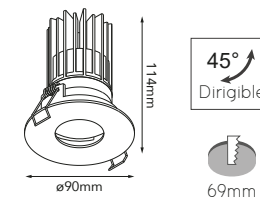

06-6313-*

Watts: 3W
 Lúmenes: 215lm
 TC: 3000K | 4000K
 Voltaje: 90-240V
 CRI: >80
 IP: 20
 Ángulo Apertura: 40°
 Material: Aluminio

-01 Blanco

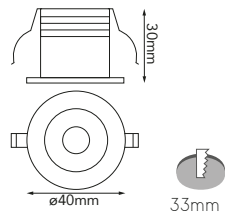

06-2315-*

Watts: 10W
 Lúmenes: 750lm
 TC: 3000K
 Voltaje: 90-130V
 CRI: >85
 IP: 20
 Ángulo Apertura: 24°
 Material: Aluminio

-01 Blanco -07 Negro

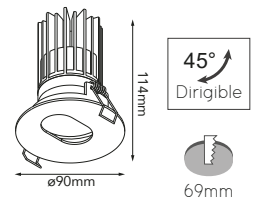

*NOTA: Driver incluido



06-9035-*

Watts: 13W
 Lúmenes: 1040lm
 TC: 3000K
 Voltaje: 100-240V
 CRI: >80
 IP: 20
 Ángulo Apertura: 38°
 Material: Aluminio

-01 Blanco

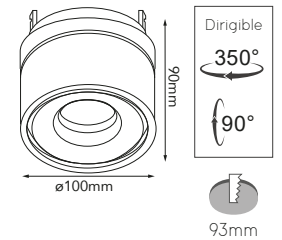

22-9036-*

Watts: 13W
 Lúmenes: 1040lm
 TC: 3000K
 Voltaje: 100-240V
 CRI: >80
 IP: 20
 Ángulo Apertura: 38°
 Material: Aluminio

-01 Blanco

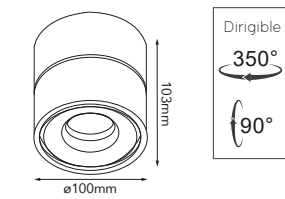

MELODY | CAMALEÓN



06-1070-*

Watts: 7W
 Lúmenes: 560lm
 TC: 3000K | 4000K
 Voltaje: 100-265V
 CRI: >80
 IP: 20
 Ángulo Apertura: 36°
 Material: Aluminio + Cristal

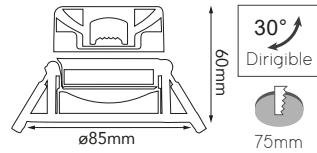

-01 Blanco



06-1090-*

Watts: 10W
 Lúmenes: 800lm
 TC: 3000K | 4000K
 Voltaje: 100-265V
 CRI: >80
 IP: 20
 Ángulo Apertura: 36°
 Material: Aluminio + Cristal

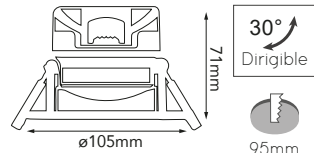

-01 Blanco



06-3108-* | 06-3108-D

Watts: 8W
 Lúmenes: 660lm
 TC: 3000K | 4000K
 Voltaje: 100-277V
 CRI: >80
 IP: 44
 Ángulo Apertura: 90°
 Material: Aluminio + Plástico

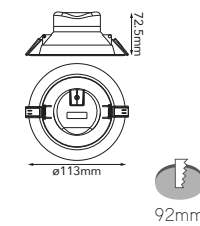

-01 Blanco -07 Negro



06-3110-* | 06-3110-D

Watts: 12W
 Lúmenes: 1050lm
 TC: 3000K | 4000K
 Voltaje: 100-277V
 CRI: >80
 IP: 44
 Ángulo Apertura: 90°
 Material: Aluminio + Plástico

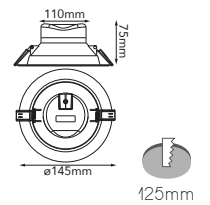

-01 Blanco -07 Negro



06-0113-*

Watts: 25W
 Lúmenes: 2400lm
 TC: 3000K | 5000K
 Voltaje: 127V
 CRI: >80
 IP: 20
 Ángulo Apertura: 36°
 Material: Aluminio

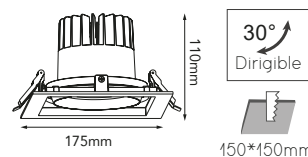

Accesorio Conexión modular

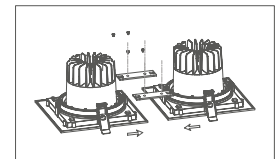

-01 Blanco -07 Negro

CON-060113
 *Se vende por separado

*NOTA: Driver TRIAC incluido



06-0114-*

Watts: 25W
 Lúmenes: 2400lm
 TC: 3000K | 5000K
 Voltaje: 127V
 CRI: >80
 IP: 20
 Ángulo Apertura: 36°
 Material: Aluminio

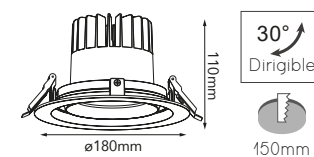

-01 Blanco -07 Negro

*NOTA: Driver TRIAC incluido



06-3117-* | 06-3117-D

Watts: 17W
 Lúmenes: 1500lm
 TC: 3000K | 4000K
 Voltaje: 100-277V
 CRI: >80
 IP: 44
 Ángulo Apertura: 90°
 Material: Aluminio + Plástico

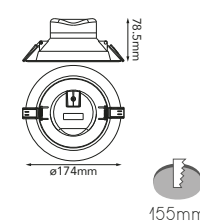

-01 Blanco -07 Negro

*D = Dimeable

*NOTA: Acabado en -07 Negro solo está disponible en versión Dimeable



06-3125-*

Watts: 25W
 Lúmenes: 2350lm
 TC: 3000K | 4000K
 Voltaje: 100-277V
 CRI: >80
 IP: 44
 Ángulo Apertura: 90°
 Material: Aluminio + Plástico

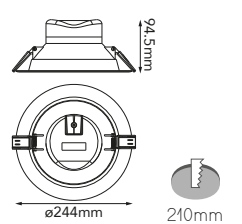

-01 Blanco

CALYPSO

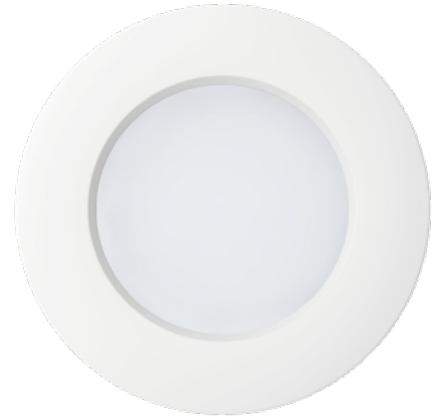

Bote integral

06-1414-*

Watts: 14W
 Lúmenes: 1400lm
 TC: 3000K | 4000K
 Voltaje: 100-240V
 CRI: >80
 IP: 20
 Ángulo Apertura: 110°
 Material: Plástico

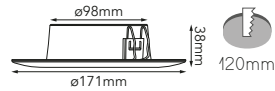

*NOTA: Para bote integral



EQUINOX



06-0305-*

Watts: 5W
 Lúmenes: 500lm
 TC: 3000K | 4000K
 Voltaje: 100-240V
 CRI: >80
 IP: 20
 Ángulo Apertura: 120°
 Material: Aluminio

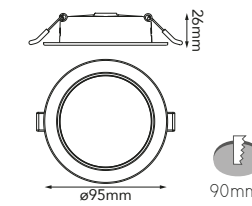

-01 Blanco

06-0409-*

Watts: 9W
 Lúmenes: 900lm
 TC: 3000K | 4000K
 Voltaje: 100-240V
 CRI: >80
 IP: 20
 Ángulo Apertura: 120°
 Material: Aluminio

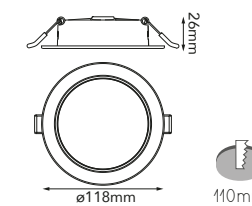

-01 Blanco -07 Negro

06-0512-*

Watts: 12W
 Lúmenes: 1200lm
 TC: 3000K | 4000K
 Voltaje: 100-240V
 CRI: >80
 IP: 20
 Ángulo Apertura: 120°
 Material: Aluminio

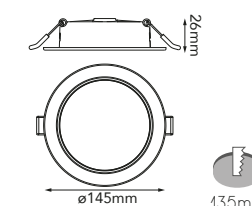

-01 Blanco -07 Negro

06-0718-*

Watts: 18W
 Lúmenes: 1800lm
 TC: 3000K | 4000K
 Voltaje: 100-240V
 CRI: >80
 IP: 20
 Ángulo Apertura: 120°
 Material: Aluminio

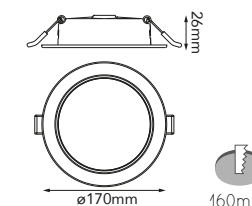

-01 Blanco -07 Negro

06-1224-*

Watts: 24W
 Lúmenes: 2440lm
 TC: 4000K
 Voltaje: 100-240V
 CRI: >80
 IP: 20
 Ángulo Apertura: 120°
 Material: Aluminio

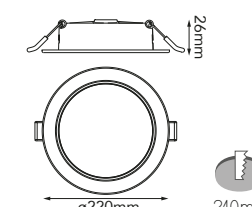

-01 Blanco -07 Negro

Marco para sobreponer



+



↓



- FR-060409
- FR-060512
- FR-060718
- FR-061224

*NOTA: Marco para sobreponer.
 Se vende por separado

PROFESIONAL



SKY



6-26951-* | 6-26951-30D

Watts: 9W
 Lúmenes: 700lm
 TC: 3000K | 4000K
 Voltaje: 90-130V
 CRI: >80
 IP: 20
 Ángulo Apertura: 25°
 Material: Aluminio

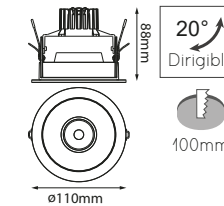

-01 Blanco



6-26957-*

Watts: 9W
 Lúmenes: 698lm
 TC: 4000K
 Voltaje: 100-240V
 CRI: >80
 IP: 20
 Ángulo Apertura: 25°
 Material: Aluminio

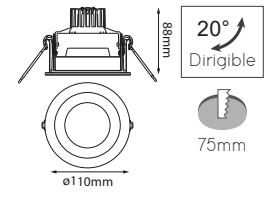

-01 Blanco



6-28151-*

Watts: 9W
 Lúmenes: 550lm
 TC: 4000K
 Voltaje: 90-130V
 CRI: >80
 IP: 20
 Ángulo Apertura: 25°
 Material: Aluminio + PMMA

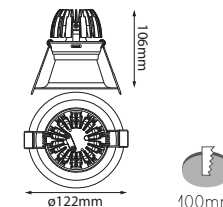

-01 Blanco



06-2751-*

Watts: 15W
 Lúmenes: 1314lm
 TC: 3000K
 Voltaje: 85-265V
 CRI: >90
 IP: 20
 Ángulo Apertura: 20°
 Material: Aluminio

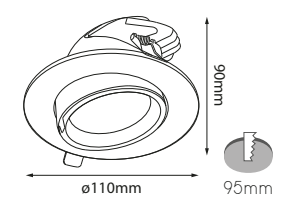

-01 Blanco -07 Negro

ATENEA | POLUX



06-8007-*

Watts: 7W
 Lúmenes: 364lm
 TC: 3000K
 Voltaje: 85-265V
 CRI: >90
 IP: 20
 Ángulo Apertura: 34°
 Material: Aluminio

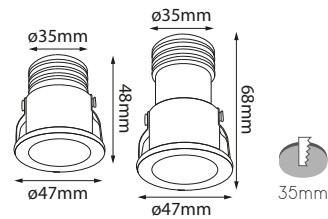

-01 Blanco -07 Negro



06-8012-*

Watts: 12W
 Lúmenes: 1025lm
 TC: 3000K
 Voltaje: 85-265V
 CRI: >90
 IP: 20
 Ángulo Apertura: 34°
 Material: Aluminio

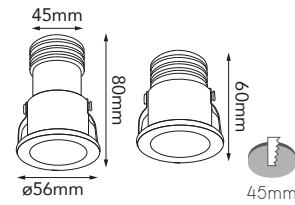

-01 Blanco -07 Negro



06-8318-*

Watts: 18W
 Lúmenes: 1506lm
 TC: 3000K
 Voltaje: 85-265V
 CRI: >90
 IP: 20
 Ángulo Apertura: 34°
 Material: Aluminio

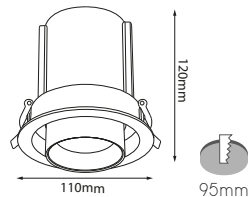

-01 Blanco -07 Negro



06-8325-*

Watts: 25W
 Lúmenes: 2033lm
 TC: 3000K
 Voltaje: 85-265V
 CRI: >90
 IP: 20
 Ángulo Apertura: 34°
 Material: Aluminio

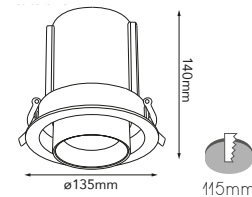

-01 Blanco -07 Negro



06-7091-*

Watts: 2W
 Lúmenes: 119lm
 TC: 3000K
 Voltaje: 85-265V
 CRI: >90
 IP: 20
 Ángulo Apertura: 23°
 Material: Aluminio

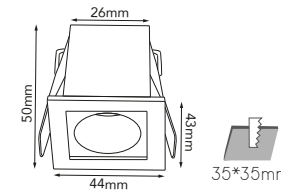

-01 Blanco -07 Negro



06-7092-*

Watts: 4W
 Lúmenes: 270lm
 TC: 3000K
 Voltaje: 85-265V
 CRI: >90
 IP: 20
 Ángulo Apertura: 23°
 Material: Aluminio

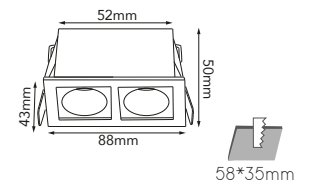

-01 Blanco -07 Negro



06-7093-*

Watts: 6W
 Lúmenes: 700lm
 TC: 3000K
 Voltaje: 85-265V
 CRI: >90
 IP: 20
 Ángulo Apertura: 23°
 Material: Aluminio

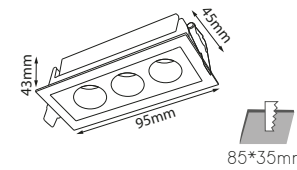

-01 Blanco -07 Negro



06-7095-*

Watts: 10W
 Lúmenes: 900lm
 TC: 3000K
 Voltaje: 85-265V
 CRI: >90
 IP: 20
 Ángulo Apertura: 23°
 Material: Aluminio

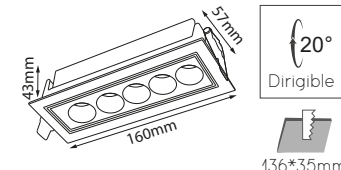

-01 Blanco -07 Negro

VULCANO



06-7010-*

Watts: 20W
 Lúmenes: 1800lm
 TC: 3000K
 Voltaje: 85-265V
 CRI: >90
 IP: 20
 Ángulo Apertura: 23°
 Material: Aluminio

-01 Blanco y -07 Negro

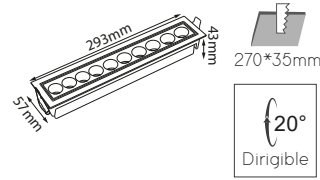

22-7093-*

Watts: 6W
 Lúmenes: 700lm
 TC: 3000K
 Voltaje: 85-265V
 CRI: >90
 IP: 20
 Ángulo Apertura: 23°
 Material: Aluminio

-01 Blanco y -07 Negro

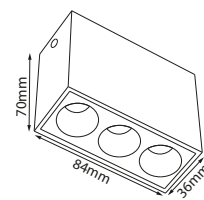

22-7095-*

Watts: 10W
 Lúmenes: 900lm
 TC: 3000K
 Voltaje: 85-265V
 CRI: >90
 IP: 20
 Ángulo Apertura: 23°
 Material: Aluminio

-01 Blanco y -07 Negro

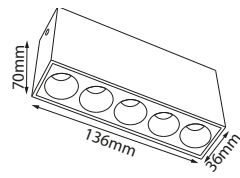

PROMETEO | HÉRCULES



22-6503-*

Base: GU10
 IP: 20
 Material: Aluminio
 -01 Blanco -07 Negro

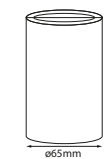

22-6504-*

Base: GU10
 IP: 20
 Material: Aluminio
 -01 Blanco -07 Negro

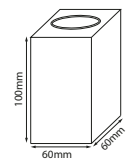

11-2409-*

Base: GU10
 IP: 20
 Material: Aluminio
 -01 Blanco -07 Negro

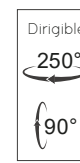
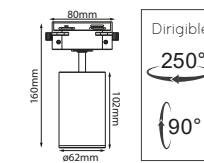

22-2409-*

Base: GU10
 IP: 20
 Material: Aluminio
 -01 Blanco -07 Negro

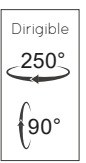
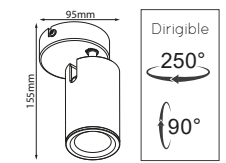

*NOTA: Focos y Riel se venden por separado

HÉRCULES



11-5009-*

Watts: 10W
Lúmenes: 950lm
TC: 3000K | 4000K
Voltaje: 100-240V
CRI: >90
IP: 20
Ángulo Apertura: 24°
Material: Aluminio

-01 Blanco -07 Negro

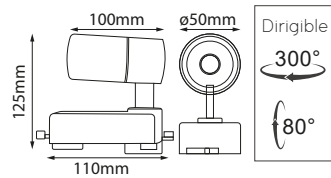

11-3001-*

Watts: 32W
Lúmenes: 2532lm
TC: 3000K
Voltaje: 100-240V
CRI: >80
IP: 20
Ángulo Apertura: 24°
Material: Aluminio

-01 Blanco

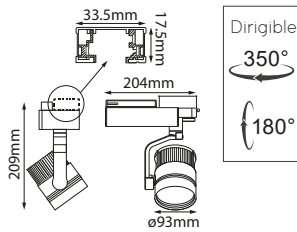

22-3002-*

Watts: 28W
Lúmenes: 1805lm
TC: 4000K
Voltaje: 100-240V
CRI: >80
IP: 20
Ángulo Apertura: 24°
Material: Aluminio

-01 Blanco

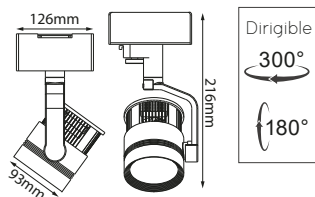

11-1735-*

Watts: 35W
Lúmenes: 3450lm
TC: 3000K | 5000K
Voltaje: 127V
CRI: >80
IP: 20
Ángulo Apertura: 10° a 60°
Material: Aluminio

-01 Blanco -07 Negro

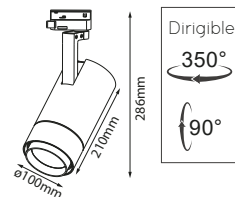

11-2815-*

Watts: 15W
Lúmenes: 1550lm
SW CCT: 3000K | 4000K | 5000K
Voltaje: 127V
CRI: >90
IP: 20
Ángulo Apertura: 24°
Material: Aluminio

-01 Blanco -07 Negro

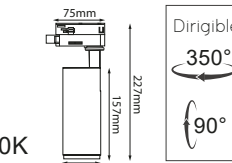

LEN-2815-45

*Se vende por separado



12-2815-*

Watts: 15W
Lúmenes: 1550lm
SW CCT: 3000K | 4000K | 5000K
Voltaje: 127V
CRI: >90
IP: 20
Ángulo Apertura: 24°
Material: Aluminio

-01 Blanco -07 Negro

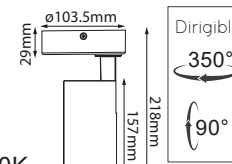

LEN-2815-45

*Se vende por separado

PANDORA



11-2825-*

Watts: 25W
Lúmenes: 2400lm
SW CCT: 3000K | 4000K | 5000K
Voltaje: 127V
CRI: >90
IP: 20
Ángulo Apertura: 24°
Material: Aluminio

-01 Blanco -07 Negro

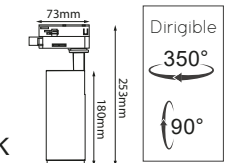

LEN-2825-36

*Se vende por separado



12-2825-*

Watts: 25W
Lúmenes: 2900lm
SW CCT: 3000K | 4000K | 5000K
Voltaje: 127V
CRI: >90
IP: 20
Ángulo Apertura: 24°
Material: Aluminio

-01 Blanco -07 Negro

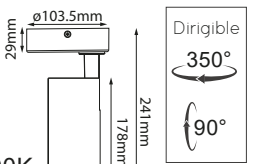

LEN-2825-36

*Se vende por separado

*NOTA: Driver incluido. Riel se vende por separado

*NOTA: Lentes intercambiables, consultar fichas técnicas

PANDORA



22-2815-*

Watts: 15W
Lúmenes: 1600lm
TC: 3000K
Voltaje: 127V
CRI: >90
IP: 20
Ángulo Apertura: 60°
Material: Aluminio

-01 Blanco -07 Negro

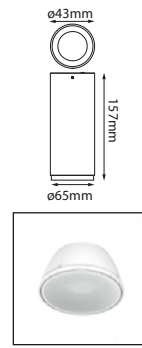

LEN-2825-36
**Se vende por separado*



22-2825-*

Watts: 25W
Lúmenes: 2900lm
TC: 3000K
Voltaje: 127V
CRI: >90
IP: 20
Ángulo Apertura: 45°
Material: Aluminio

-01 Blanco -07 Negro

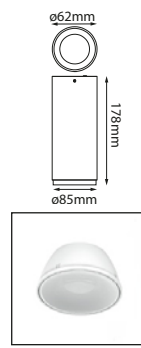

LEN-2825-36
**Se vende por separado*



23-2815-*

Watts: 15W
Lúmenes: 1600lm
SW CCT: 3000K | 4000K | 5000K
Voltaje: 127V
CRI: >90
IP: 20
Ángulo Apertura: 60°
Material: Aluminio

-01 Blanco -07 Negro

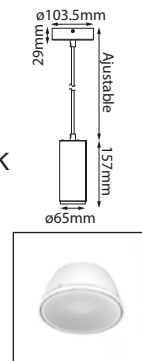

LEN-2825-36
**Se vende por separado*



23-2825-*

Watts: 25W
Lúmenes: 2900lm
SW CCT: 3000K | 4000K | 5000K
Voltaje: 127V
CRI: >90
IP: 20
Ángulo Apertura: 45°
Material: Aluminio

-01 Blanco -07 Negro

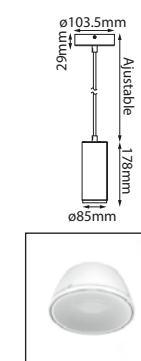

LEN-2825-36
**Se vende por separado*

*NOTA: Lentes intercambiables, consultar fichas técnicas

RIEL

Riel de Empotrar



TR-0310-*

Longitud: 1m
-01 Blanco -07 Negro

TR-0320-*

Longitud: 2m
-01 Blanco -07 Negro

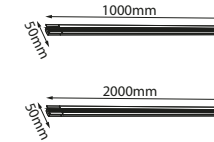

Conectores para Riel de Empotrar

-01 Blanco -07 Negro



XR-361L-*

Acometida izquierda



XR-361R-*

Acometida derecha



XR-363L-*

Conector en "L" izquierda



XR-363R-*

Conector en "L" derecha



XR-0362-*

Conector de continuidad



XR-0367-*

Conector de continuidad interno



XR-0366-*

Tapa final



XR-0365-*

Conector en "X"



XR-0364LL-*

Conector en "T" izquierda



XR-0364RL-*

Conector en "T" izquierda



XR-0364RR-*

Conector en "T" derecha



XR-0364LR-*

Conector en "T" derecha



XR-369R-*

Conector ángulo ajustable derecha



XR-369L-*

Conector ángulo ajustable izquierda

NOTA: Todos los rieles incluyen un conector inicial y una tapa final XR-0366-

RIEL



TRK-1000-* Longitud: 1m
 -01 Blanco -07 Negro

TRK-2000-* Longitud: 2m
 -01 Blanco -07 Negro

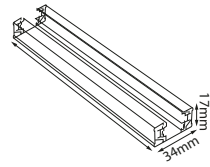

Conectores para Riel de Sobreponer

-01 Blanco -07 Negro



CON-I1-*
 Acometida inicial



CON-B2-*
 Conector de continuidad interno



CON-L3-*
 Conector en "L"



CON-T4-*
 Conector en "T"

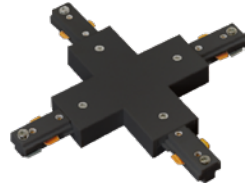

CON-X5-*
 Conector en "X"



CON-F6
 Conector flexible ángulo ajustable

*NOTA: Incluyen un conector inicial y una tapa final

TRACK MAGNÉTICO

Con un diseño discreto y contemporáneo, el riel magnético se integra de forma armoniosa en cualquier entorno, ya sea comercial o residencial.

TH-100-* Longitud: 1m
 -01 Blanco -07 Negro

TH-200-* Longitud: 2m
 -01 Blanco -07 Negro

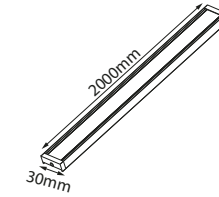
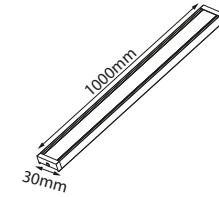

Fuente de Poder Riel Magnético

M-TRA100-*
 Watts: 100W
 Entrada: 127V, Salida 48V CD
 IP: 20
 Material: Aluminio
 -01 Blanco -07 Negro

M-TRA200-*
 Watts: 200W
 Entrada: 127V, Salida 48V CD
 IP: 20
 Material: Aluminio
 -01 Blanco -07 Negro

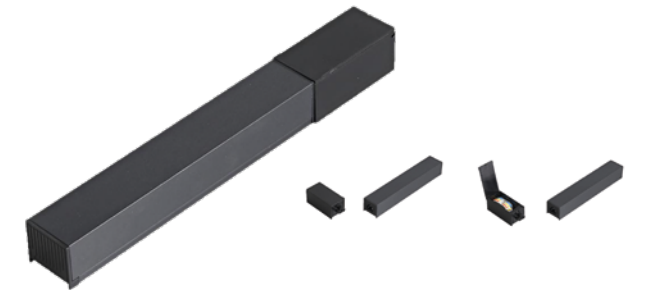

Conectores Riel Magnético: -01 Blanco -07 Negro

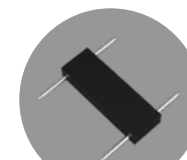

C-001-*



C-005P-*

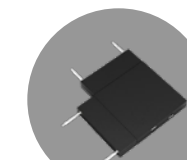

C-002L-*

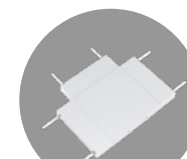

C-003T-*

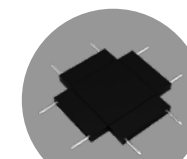

C-004C-*



*Tapa final incluida

Inserte la clavija de cobre en el módulo principal

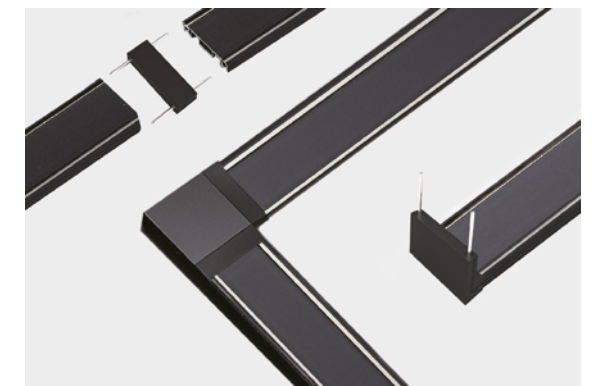

TRACK MAGNÉTICO



30-0300-*

Watts: 11W
Lúmenes: 880lm
TC: 3000K | 4000K
Voltaje: 48V CD
CRI: >90
IP: 20
Ángulo Apertura: 111°
Material: Aluminio

-01 Blanco -07 Negro

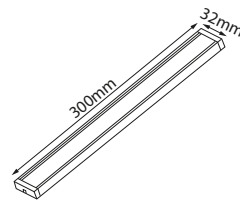

30-0600-*

Watts: 24W
Lúmenes: 1920lm
TC: 3000K | 4000K
Voltaje: 48V CD
CRI: >90
IP: 20
Ángulo Apertura: 111°
Material: Aluminio

-01 Blanco -07 Negro

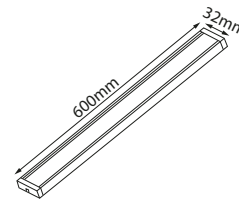

30-0054-*

Watts: 9W
Lúmenes: 720lm
TC: 3000K | 4000K
Voltaje: 48V CD
CRI: >90
IP: 20
Ángulo Apertura: 25°
Material: Aluminio

-01 Blanco -07 Negro

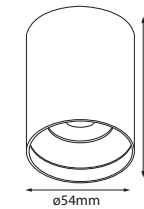

30-0055-*

Watts: 7W
Lúmenes: 560lm
TC: 3000K | 4000K
Voltaje: 48V CD
CRI: >90
IP: 20
Ángulo Apertura: 25°
Material: Aluminio

-01 Blanco -07 Negro

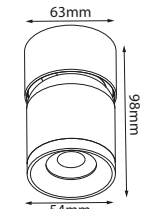

30-0024-*

Watts: 12W
Lúmenes: 960lm
TC: 3000K | 4000K
Voltaje: 48V CD
CRI: >90
IP: 20
Ángulo Apertura: 31°
Material: Aluminio

-01 Blanco -07 Negro

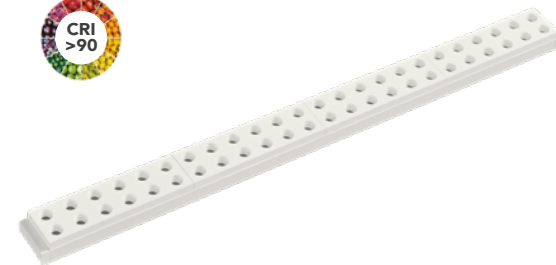
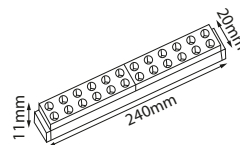

30-0048-*

Watts: 21W
Lúmenes: 1680lm
TC: 3000K | 4000K
Voltaje: 48V CD
CRI: >90
IP: 20
Ángulo Apertura: 31°
Material: Aluminio

-01 Blanco -07 Negro

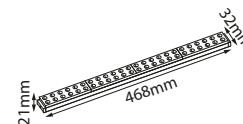

30-0811-*

Watts: 6W
Lúmenes: 480lm
TC: 3000K | 4000K
Voltaje: 48V CD
CRI: >90
IP: 20
Ángulo Apertura: 80°
Material: Aluminio

-01 Blanco -07 Negro

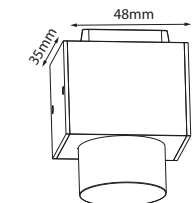

30-2307-*

Watts: 7W
Lúmenes: 560lm
TC: 3000K | 4000K
Voltaje: 48V CD
CRI: >90
IP: 20
Ángulo Apertura: 25°
Material: Aluminio

-01 Blanco -07 Negro

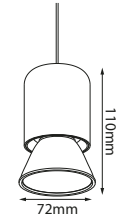

*Accesorio para el Track Magnético

TRACK MAGNÉTICO



30-0007-*

Watts: 7W
Lúmenes: 560lm
TC: 3000K | 4000K
Voltaje: 48V CD
CRI: >90
IP: 20
Ángulo Apertura: 25°
Material: Aluminio

-01 Blanco -07 Negro

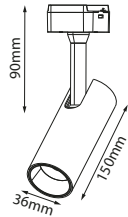

30-0012-*

Watts: 12W
Lúmenes: 960lm
TC: 3000K | 4000K
Voltaje: 48V CD
CRI: >90
IP: 20
Ángulo Apertura: 24°
Material: Aluminio

-01 Blanco -07 Negro

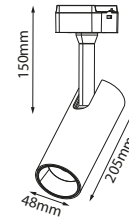

30-2308-*

Watts: 7W
Lúmenes: 560lm
TC: 3000K | 4000K
Voltaje: 48V CD
CRI: >90
IP: 20
Ángulo Apertura: 21°
Material: Aluminio

-01 Blanco -07 Negro

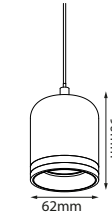

30-0510-*

Watts: 11W
Lúmenes: 880lm
TC: 3000K | 4000K
Voltaje: 48V CD
CRI: >90
IP: 20
Ángulo Apertura: 25°
Material: Aluminio

-01 Blanco -07 Negro

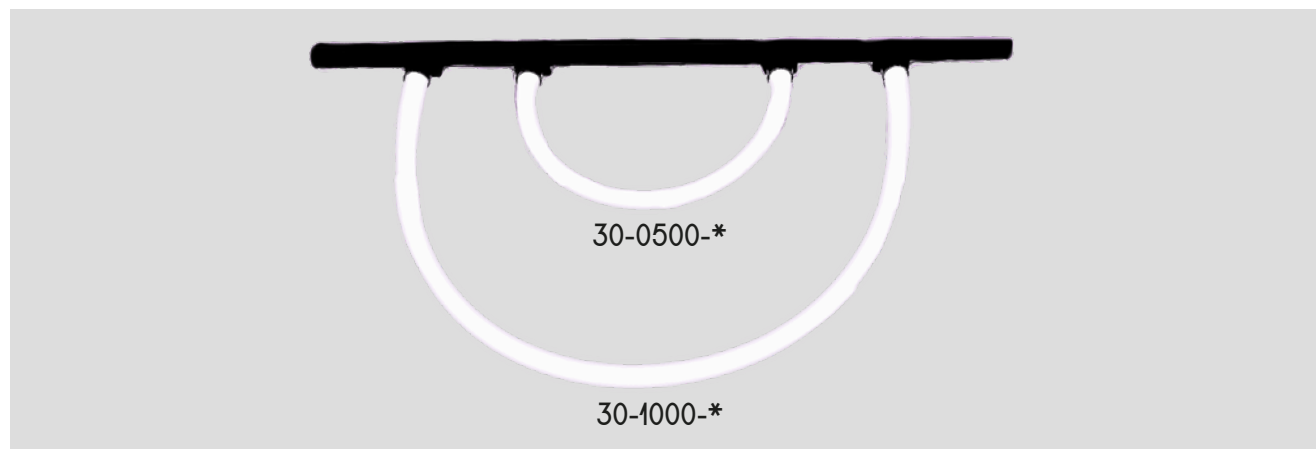
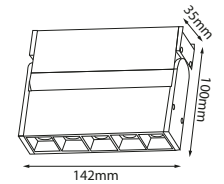

30-0500-*

Watts: 10W
Lúmenes: 800lm
TC: 3000K | 4000K
Voltaje: 48V CD
CRI: >90
IP: 20
Ángulo Apertura: 360°
Material: Aluminio

-01 Blanco -07 Negro

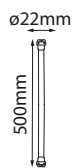

30-1000-*

Watts: 20W
Lúmenes: 1600lm
TC: 3000K | 4000K
Voltaje: 48V CD
CRI: >90
IP: 20
Ángulo Apertura: 360°
Material: Aluminio

-01 Blanco -07 Negro

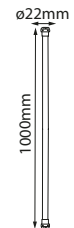

30-0010-*

Watts: 19W
Lúmenes: 1520lm
TC: 3000K | 4000K
Voltaje: 48V CD
CRI: >90
IP: 20
Ángulo Apertura: 105°
Material: Aluminio

-01 Blanco -07 Negro

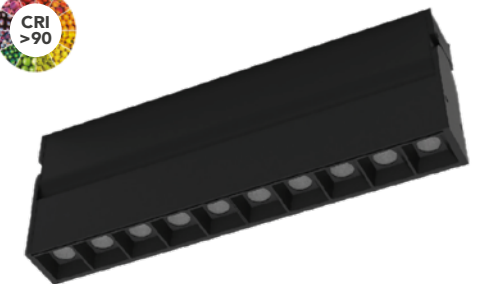
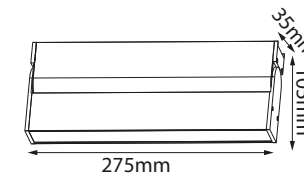

30-0520-*

Watts: 20W
Lúmenes: 1600lm
TC: 3000K | 4000K
Voltaje: 48V CD
CRI: >90
IP: 20
Ángulo Apertura: 25°
Material: Aluminio

-01 Blanco -07 Negro

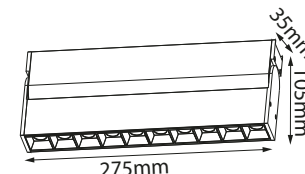

DASH

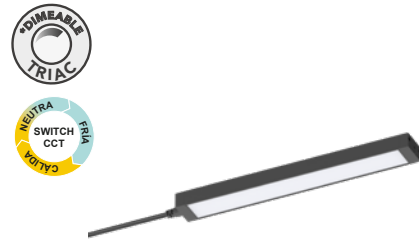

22-3005-*

Watts: 5W
 Lúmenes: 400lm
 SW CCT: 3000K | 4000K | 5700K
 Voltaje: 100-130V
 CRI: >80
 IP: 20
 Ángulo Apertura: 100°
 Material: Aluminio + PC

-01 Blanco -07 Negro

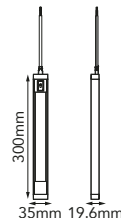

22-6010-*

Watts: 10W
 Lúmenes: 800lm
 SW CCT: 3000K | 4000K | 5700K
 Voltaje: 100-130V
 CRI: >80
 IP: 20
 Ángulo Apertura: 100°
 Material: Aluminio + PC

-01 Blanco -07 Negro

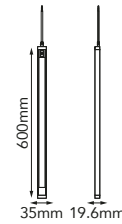

22-6136-*

Watts: 36W
 Lúmenes: 2880lm
 TC: 5000K
 Voltaje: 100-240V
 CRI: >80
 IP: 20
 Ángulo Apertura: 120°
 Material: Aluminio

-01 Blanco

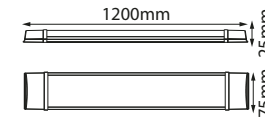

ALPHA | LINE



06-2011-*

Watts: 40W
 Lúmenes: 4000lm
 TC: 3000K | 5000K
 Voltaje: 100-240V
 CRI: >80
 IP: 20
 Ángulo Apertura: 110°
 Material: Aluminio

-01 Blanco

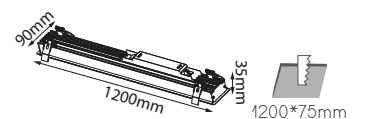

22-1220-*

Watts: 20W
 Lúmenes: 1600lm
 SW CCT: 3000K | 4000K | 5700K
 Voltaje: 100-130V
 CRI: >80
 IP: 20
 Ángulo Apertura: 100°
 Material: Aluminio + PC

-01 Blanco -07 Negro

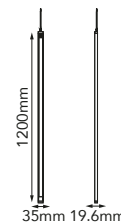

Accesorios:

CON-3005-*

*Conector

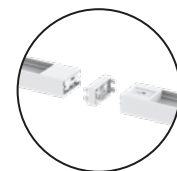

-01 Blanco -07 Negro

CBL-3005-*

*Cable para colgar



22-2060-*

Watts: 20W
 Lúmenes: 1600lm
 TC: 5000K
 Voltaje: 85-265V
 CRI: >80
 IP: 20
 Ángulo Apertura: 110°
 Material: Aluminio + PC

-03 Gris

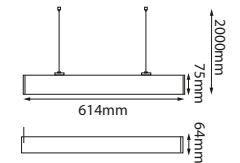

CON-2011

*Se vende por separado

LINE

Antideslumbramiento ✨



22-1232-*

Watts: 30W
Lúmenes: 3000lm
SW CCT: 3000K | 4000K | 6500K
Voltaje: 100-270V
CRI: >80
IP: 20

Ángulo Apertura: 80°
Material: Aluminio + PC

01 Blanco 07 Negro

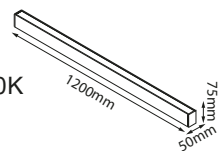

22-1216-*

Watts: 16W
Lúmenes: 1700lm
SW CCT: 3000K | 4000K | 5000K
Voltaje: 85-265V
CRI: >80
IP: 20

Ángulo Apertura: 80°
Material: Aluminio + PC

01 Blanco 07 Negro

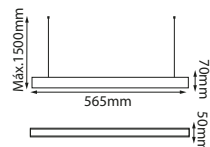

*NOTA: No incluye cable de alimentación

*NOTA: No incluye cable de alimentación

Accesorios:

*Se venden por separado

Material: Aluminio



Kit de suspensión y sobreponer

Incluido - 2m de cable



CONT-221232-*

Watts: 10W
Lúmenes: 1000lm

01 Blanco 07 Negro

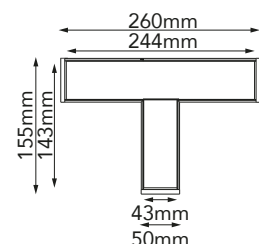

CONL-221232-*

Watts: 8W
Lúmenes: 800lm

01 Blanco 07 Negro

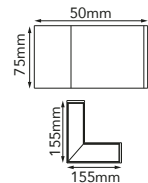

CONX-221232-*

Watts: 14W
Lúmenes: 1400lm

01 Blanco 07 Negro

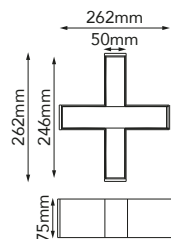

CON-221232-*

01 Blanco 07 Negro

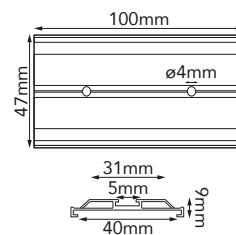

*Interconectable eléctricamente hasta 600W

ATLAS

Antideslumbramiento ✨

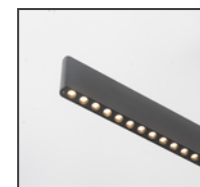

22-1130-*

Watts: 31W
Lúmenes: 2400lm
SW CCT: 3000K | 4000K | 6000K
Voltaje: 127V

CRI: >80
UGR ≤ 16
IP: 20
Ángulo Apertura: 24°
Material: Aluminio

07 Negro

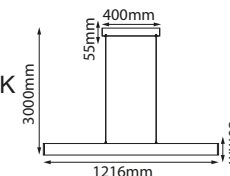

*NOTA: Altura ajustable 3m de cable

SLIM



23-1300-*

Watts: 5W
 Lúmenes: 480lm
 TC: 3000K
 Voltaje: 127V
 CRI: >80
 IP: 20
 Ángulo Apertura: 30°
 Material: Aluminio

-01 Blanco -07 Negro -14 Oro Cepillado

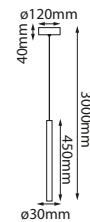

*NOTA: Altura ajustable 3m de cable

LED PANEL

Antideslumbramiento ✨



Accesorios

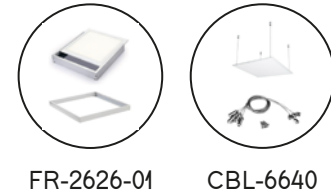

FR-2626-01 CBL-6640

Accesorios

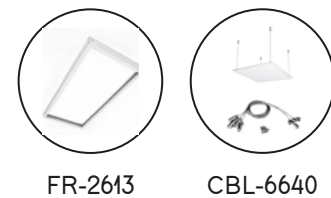

FR-2613 CBL-6640

Accesorios

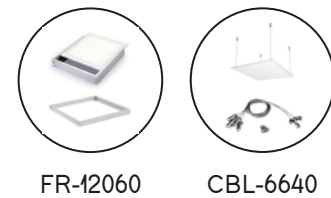

FR-12060 CBL-6640

26-6640-40

Watts: 38W
 Lúmenes: 3420lm
 TC: 4000K
 Voltaje: 85-265V
 CRI: >80
 IP: 20
 FP 0.7
 Ángulo Apertura: 120°
 Material: Aluminio + PC

-01 Blanco

26-6640-50

Watts: 40W
 Lúmenes: 3600lm
 TC: 5000K
 Voltaje: 110-240V
 CRI: >80
 IP: 20
 Ángulo Apertura: 120°
 Material: Aluminio + PC

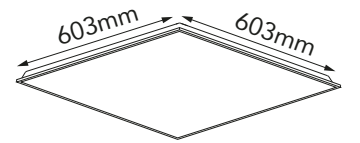

26-6640-CCT

Watts: 38W
 Lúmenes: 3420lm
 SW CCT: 3000K | 4000K | 5000K
 Voltaje: 85-265V
 CRI: >80
 IP: 20
 FP 0.7
 Ángulo Apertura: 120°
 Material: Aluminio + PC

-01 Blanco

26-1340-50

Watts: 40W
 Lúmenes: 3600lm
 TC: 5000K
 Voltaje: 85-265V
 CRI: >80
 IP: 20
 Ángulo Apertura: 120°
 Material: Aluminio + PC

-01 Blanco

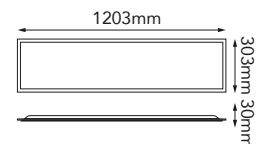

26-6675-40

Watts: 96W
 Lúmenes: 8640lm
 TC: 4000K
 Voltaje: 85-265V
 CRI: >80
 IP: 20
 FP 0.7
 Ángulo Apertura: 120°
 Material: Aluminio + PC

-01 Blanco

26-6675-50

Watts: 75W
 Lúmenes: 6700lm
 TC: 5000K
 Voltaje: 85-265V
 CRI: >80
 IP: 20
 Ángulo Apertura: 120°
 Material: Aluminio + PC

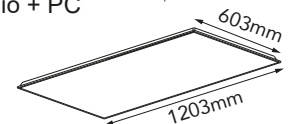

CORTESÍA

CONUS



05-2799-* | 05-2805-*
(kit 3 pzas)

Watts: 1W
Lúmenes: 60lm
TC: 3000K | 4000K | 5000K
Voltaje: 12V CA
CRI: >80
IP: 67
Material: Aluminio
-12 Aluminio

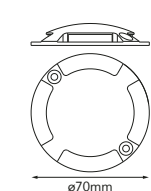

05-2800-* | 05-2806-*
(kit 3 pzas)

Watts: 0.8W
Lúmenes: 40lm
TC: 3000K | 4000K | 5000K
Voltaje: 12V CA
CRI: >80
IP: 67
Material: Aluminio
-12 Aluminio

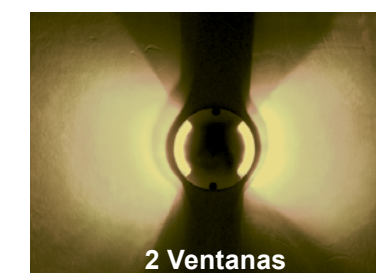
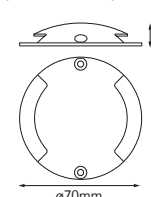

05-2801-* | 05-2807-*
(kit 3 pzas)

Watts: 0.5W
Lúmenes: 20lm
TC: 3000K | 4000K | 5000K
Voltaje: 12V CA
CRI: >80
IP: 67
Material: Aluminio
-12 Aluminio

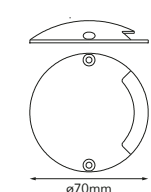

*Nota: Solo en KIT incluye transformador

SIGN | KRAKEN



07-1276-*

Watts: 3W
 Lúmenes: 160lm
 TC: 3000K
 Voltaje: 90-240V
 CRI: >80
 IP: 54
 Material: Aluminio

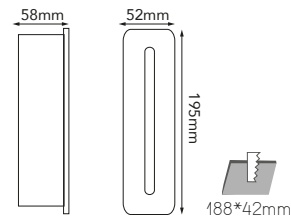

-01 Blanco -03 Gris

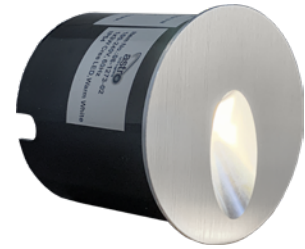

08-1273-*

Watts: 3W
 Lúmenes: 160lm
 TC: 3000K
 Voltaje: 100-240V
 CRI: >80
 IP: 54
 Material: Aluminio

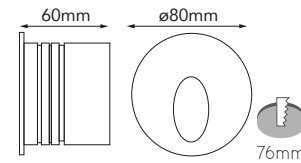

-02 Satinado

SHARK



05-9001-*

Watts: 3.5W
 Lúmenes: 170lm
 TC: 3000K
 Voltaje: 90-130V
 CRI: >80
 IP: 54
 Material: Aluminio + Cristal

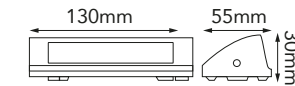

-01 Blanco -03 Gris -07 Negro



08-7401-*

Watts: 1.5W
 Lúmenes: 75lm
 TC: 3000K
 Voltaje: 90-130V
 CRI: >80
 IP: 65
 Material: Aluminio + SS316

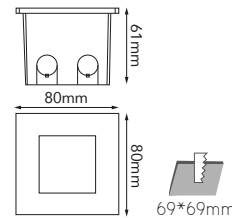

-01 Blanco -08 Acero



08-7501-*

Watts: 1.5W
 Lúmenes: 75lm
 TC: 3000K
 Voltaje: 90-130V
 CRI: >80
 IP: 65
 Material: Aluminio + SS316

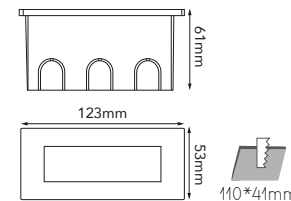

-08 Acero



08-9002-*

Watts: 8W
 Lúmenes: 530lm
 TC: 3000K
 Voltaje: 90-130V
 CRI: >80
 IP: 54
 Material: Aluminio + Cristal

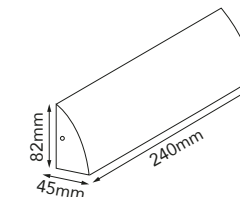

-03 Gris -07 Negro

*Nota: Driver y caja de registro incluidos

*Nota: Driver incluido

KELPIE



07-4201-*

Watts: 1W
 Lúmenes: 60lm
 TC: 3000K
 Voltaje: 100-240V
 CRI: >80
 IP: 54
 Ángulo Apertura: 120°
 Material: Aluminio + Cristal
 -03 Gris

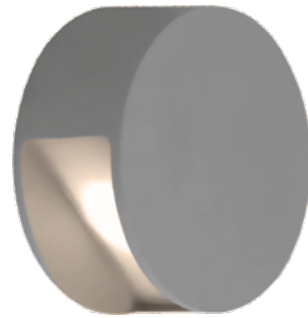
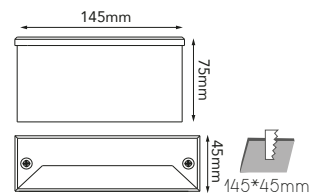

05-7001-*

Watts: 4W
 Lúmenes: 320lm
 TC: 3000K
 Voltaje: 100-240V
 CRI: >80
 IP: 44
 Ángulo Apertura: 90°
 Material: Aluminio
 -03 Gris

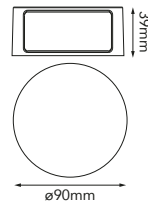

08-1901-*

Watts: 6W
 Lúmenes: 140lm
 TC: 3000K
 Voltaje: 100-240V
 CRI: >80
 IP: 54
 Material: Aluminio
 -01 Blanco -04 Grafito

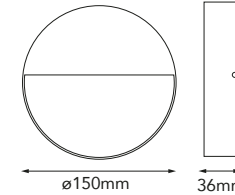

08-2201-*

Watts: 6W
 Lúmenes: 140lm
 TC: 3000K
 Voltaje: 100-240V
 CRI: >80
 IP: 54
 Material: Aluminio
 -01 Blanco -04 Grafito

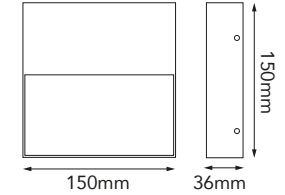

07-1280-*

Watts: 1.5W
 Lúmenes: 90lm
 TC: 3000K
 Voltaje: 127V
 CRI: >80
 IP: 65
 Material: Aluminio
 -03 Gris

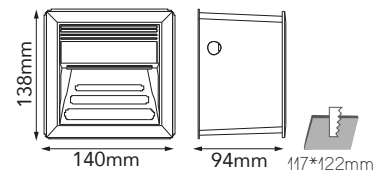

08-2203-*

Watts: 6W
 Lúmenes: 140lm
 TC: 3000K
 Voltaje: 100-240V
 CRI: >80
 IP: 54
 Material: Aluminio
 -01 Blanco -04 Grafito

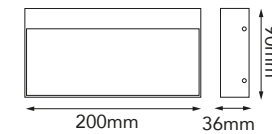

SMART

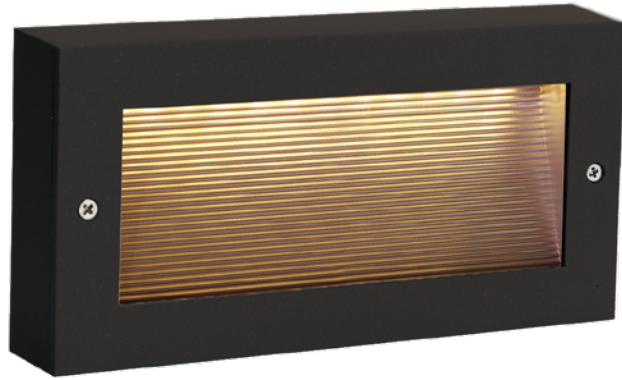
**08-9245-***

Watts: 2.6W
 Lúmenes: 208lm
 TC: 3000K
 Voltaje: 100-240V
 CRI: >80
 IP: 44
 Material: Aluminio

-01 Blanco -03 Gris -07 Negro

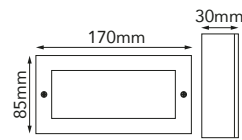
**08-8301-***

Watts: 3W
 Lúmenes: 105lm
 TC: 3000K
 Voltaje: 90-130V
 CRI: >80
 IP: 54
 Ángulo Apertura: 110°
 Material: Aluminio + Cristal

-01 Blanco -03 Gris -04 Grafito

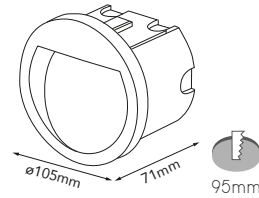
**08-8401-***

Watts: 3W
 Lúmenes: 105lm
 TC: 3000K
 Voltaje: 90-130V
 CRI: >80
 IP: 54
 Ángulo Apertura: 110°
 Material: Aluminio + Cristal

-01 Blanco -03 Gris -04 Grafito

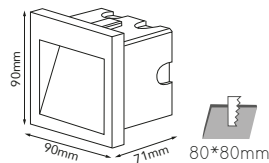
**08-8501-***

Watts: 3W
 Lúmenes: 105lm
 TC: 3000K
 Voltaje: 90-130V
 CRI: >80
 IP: 54
 Ángulo Apertura: 110°
 Material: Aluminio + Cristal

-01 Blanco -03 Gris -04 Grafito

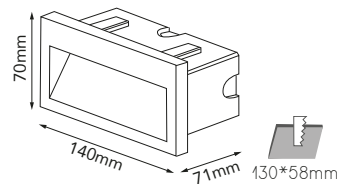

OUTDOOR PARED



*Nota: Driver incluido

VALI



05-4030-*

Base: 2*GU10

Voltaje: 127V

IP: 65

Material: Nylon de Fibra de Carbón
+ Difusor Cristal Templado

-01 Blanco -07 Negro

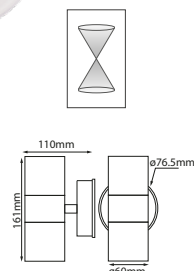

05-4031-*

Base: GU10

Voltaje: 127V

IP: 65

Material: Nylon de Fibra de Carbón
+ Difusor Cristal Templado

-01 Blanco -07 Negro

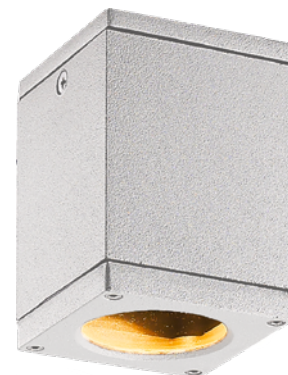
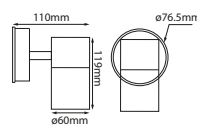

22-7161-*

Base: GU10

Voltaje: 127

IP: 44

Material: Aluminio + Cristal
*A Techo

-01 Blanco -03 Gris -04 Grafito

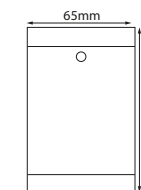

05-7493-*

Base: GU10

Voltaje: 127

IP: 44

Material: Aluminio + Cristal

-01 Blanco -03 Gris -04 Grafito

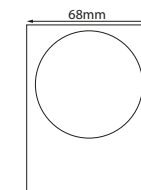

05-4033-*

Base: GU10

Voltaje: 127V

IP: 65

Material: Nylon de Fibra de Carbón
+ Difusor Cristal Templado

-01 Blanco -07 Negro

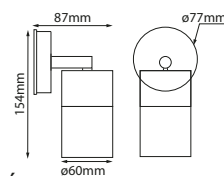

22-4032-*

Base: GU10

Voltaje: 127V

IP: 65

Material: Nylon de Fibra de Carbón
+ Difusor Cristal Templado

-01 Blanco -07 Negro

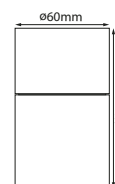

05-7494-*

Base: 2*GU10

Voltaje: 127

IP: 44

Material: Aluminio + Cristal

-01 Blanco -03 Gris -04 Grafito

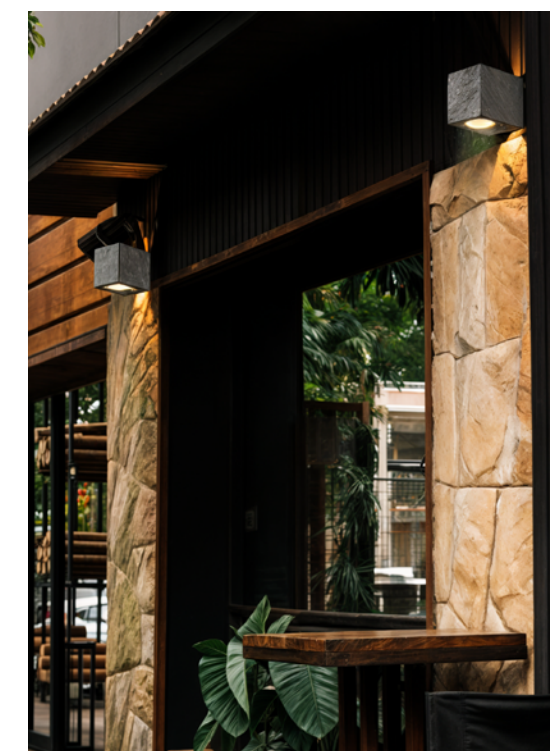
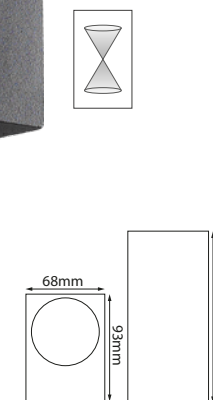

Tapa para registro:

PR-0012-*

-01 Blanco -03 Gris

-04 Grafito -07 Negro

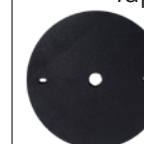

*Nota: Focos se venden por separado

*Nota: Focos y accesorios se venden por separado

ODÍN



22-9051-*

Base: GU10
 Voltaje: 127V
 IP: 44
 Material: Aluminio + Cristal
 *A Techo

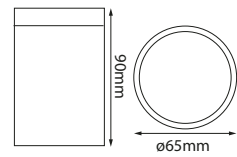

-01 Blanco -03 Gris -04 Grafito



05-8054-*

Base: GU10
 Voltaje: 127V
 IP: 44
 Material: Aluminio + Cristal

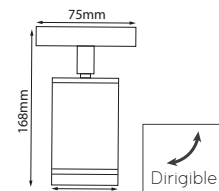

-01 Blanco -03 Gris -04 Grafito



05-7302-*

Base: E26
 Voltaje: 127
 IP: 44
 Material: Aluminio + Cristal

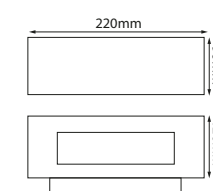

-01 Blanco -04 Grafito

OSIRIS | ARIA



22-5031-*

Base: E26
 Voltaje: 127
 IP: 54
 Material: Aluminio + Cristal
 *A Techo

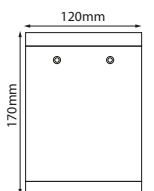

-03 Gris -04 Grafito



05-7491-*

Base: GU10
 Voltaje: 127V
 IP: 44
 Material: Aluminio + Cristal

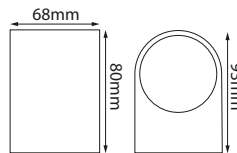

-01 Blanco -03 Gris -04 Grafito



05-7492-*

Base: 2*GU10
 Voltaje: 127V
 IP: 44
 Material: Aluminio + Cristal

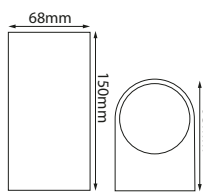

-01 Blanco -03 Gris -04 Grafito



05-5031-*

Base: E26
 Voltaje: 127
 IP: 54
 Material: Aluminio + Cristal

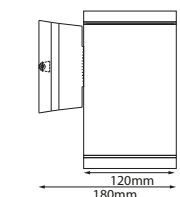

-03 Gris -04 Gráfico



05-5032-*

Base: 2*E26
 Voltaje: 127
 IP: 54
 Material: Aluminio + Cristal

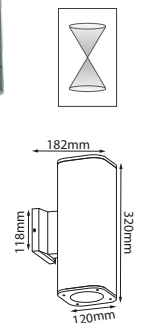

-03 Gris -04 Grafito



-01 Blanco -03 Gris
 -04 Grafito -07 Negro



-01 Blanco -03 Gris
 -04 Grafito -07 Negro

*Nota: Focos y accesorios se venden por separado

*Colección ARIA

*Nota: Focos y accesorios se venden por separado

EOS | FALCON



22-7133-*

Base: E26
 Voltaje: 127V
 IP: 44
 Material: Aluminio + Cristal
 *A Techo

-01 Blanco -03 Gris -04 Grafito

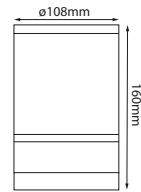

05-7131-*

Base: E26
 Voltaje: 127V
 IP: 44
 Material: Aluminio + Cristal

-01 Blanco -03 Gris -04 Grafito

*Nota: Para foco PAR-30

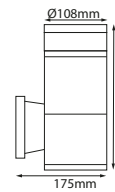

TORCH | AVALON



*Colección TORCH



05-2101-*

Base: E26
 Voltaje: 127V
 IP: 54
 Material: Aluminio + PC
 -04 Grafito

*Nota: Sugerencia de uso foco 45-1004 | 45-2604

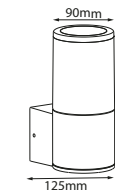

05-2102-*

Base: 2*E26
 Voltaje: 127V
 IP: 54
 Material: Aluminio + PC
 -04 Grafito

*Nota: Sugerencia de uso foco 45-1004 | 45-2604

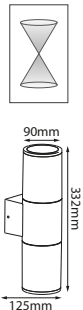

05-7132-*

Base: 2*E26
 Voltaje: 127V
 IP: 44
 Material: Aluminio + Cristal

-01 Blanco -03 Gris -04 Grafito

*Nota: Para foco PAR-20

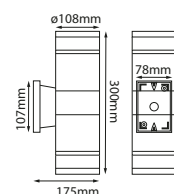

05-9006-*

Base: 2*E26
 Voltaje: 127V
 IP: 44
 Material: Plástico
 -07 Negro

*Nota: Para foco PAR-20.
 *Sugerencia de uso foco 80-0207

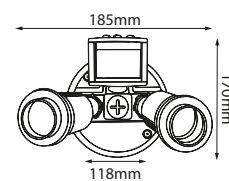

05-1241-*

Base: GU10
 Voltaje: 120V
 IP: 54
 Material: Aluminio + Cristal
 -09 ABZ

*Nota: Focos y accesorios se venden por separado

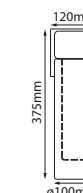

05-1248-*

Base: 2*GU10
 Voltaje: 120V
 IP: 54
 Material: Aluminio + Cristal
 -09 ABZ

*Nota: Focos y accesorios se venden por separado

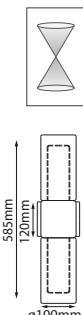

URANO



05-0093-*

Base: 2*GU10
 Voltaje: 120V
 IP: 54
 Material: Aluminio
 -07 Negro

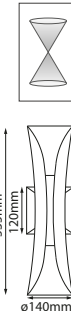

05-0094-*

Watts: 2*11W
 Lúmenes: 2*770lm
 TC: 3000K
 Voltaje: 100-240V
 CRI: >80
 IP: 54
 Material: Aluminio
 -07 Negro

ORION | BOREAL | ÁNDROMEDA



05-2701-*

Watts: 7W
 Lúmenes: 560lm
 TC: 3000K
 Voltaje: 100-240V
 CRI: >80
 IP: 44
 Ángulo Apertura: 92°
 Material: Aluminio
 -01 Blanco -04 Grafito

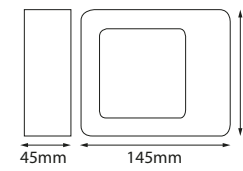

05-8107-*

Watts: 2*3W
 Lúmenes: 480lm
 TC: 3000K
 Voltaje: 100-240V
 CRI: >80
 IP: 54
 Material: Aluminio
 -01 Blanco -04 Grafito

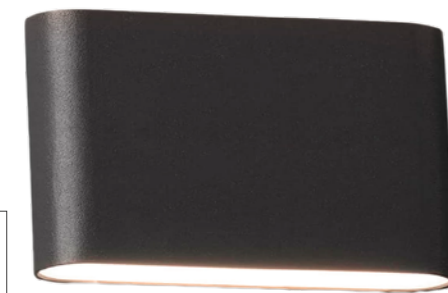
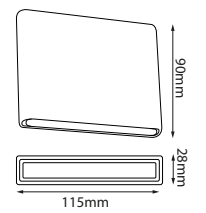

05-8108-*

Watts: 2*5W
 Lúmenes: 800lm
 TC: 3000K
 Voltaje: 100-240V
 CRI: >80
 IP: 54
 Material: Aluminio
 -01 Blanco -04 Grafito

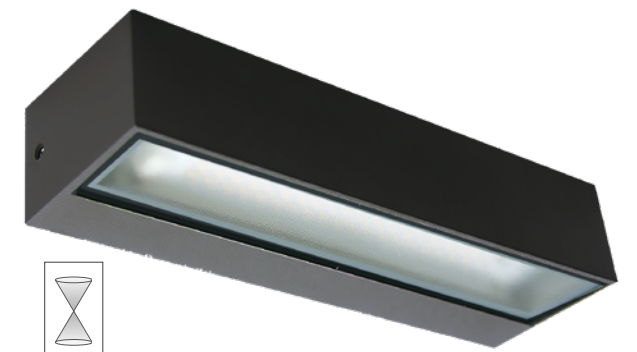
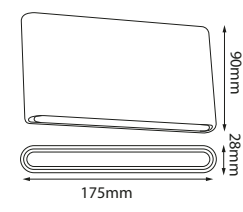

05-9801-*

Watts: 2*4W
 Lúmenes: 980lm
 TC: 3000K
 Voltaje: 100-240V
 CRI: >80
 IP: 54
 Ángulo Apertura: 85°
 Material: Aluminio + Cristal
 -03 Gris -04 Grafito

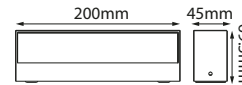

*Nota: Foco se vende por separado

CUBE | ZODIAC | OMEGA

CRONUS



05-2143-*

Watts: 18W
 Lúmenes: 1800lm
 TC: 3000K
 Voltaje: 100-240V
 CRI: >80
 IP: 65
 Material: Aluminio + PC

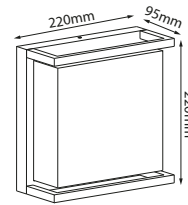

04 Grafito



05-2921-*

Watts: 8W
 Lúmenes: 700lm
 TC: 3000K
 Voltaje: 100-240V
 CRI: >80
 IP: 54
 Ángulo Apertura: 100°
 Material: Aluminio + PC
 Sensor Movimiento: 6-8m
 Diámetro de Alcance: 105°

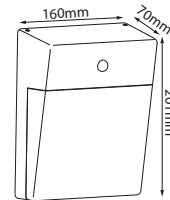

04 Grafito

*Nota: Incluye stickers de 0-9 Y A-F



05-0301-*

Watts: 1W
 Lúmenes: 82lm
 TC: 3000K
 Voltaje: 85-265V
 CRI: >80
 IP: 54
 Ángulo Apertura: 60°
 Material: Aluminio

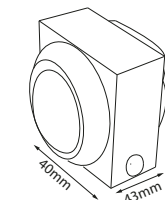

07 Negro



05-0302-*

Watts: 2W
 Lúmenes: 160lm
 TC: 3000K
 Voltaje: 85-265V
 CRI: >80
 IP: 54
 Ángulo Apertura: 60°
 Material: Aluminio

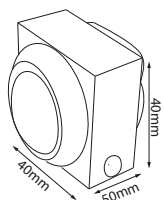

07 Negro



05-2091-*

Watts: 12W
 Lúmenes: 1000lm
 TC: 3000K
 Voltaje: 100-240V
 CRI: >80
 IP: 54
 Material: Aluminio

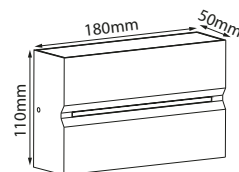

04 Grafito

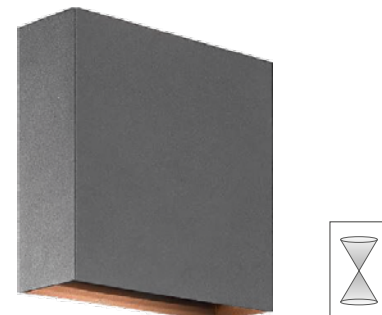

05-1018-*

Watts: 2*8W
 Lúmenes: 1120lm
 TC: 3000K
 Voltaje: 90-130V
 CRI: >80
 IP: 65
 Ángulo Apertura: 80°
 Material: Aluminio + Cristal

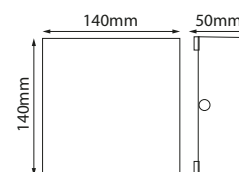

03 Gris 04 Grafito



05-0304-*

Watts: 2W
 Lúmenes: 160lm
 TC: 3000K
 Voltaje: 85-265V
 CRI: >80
 IP: 54
 Ángulo Apertura: 60°
 Material: Aluminio

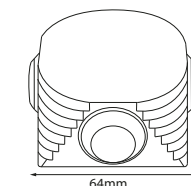

07 Negro

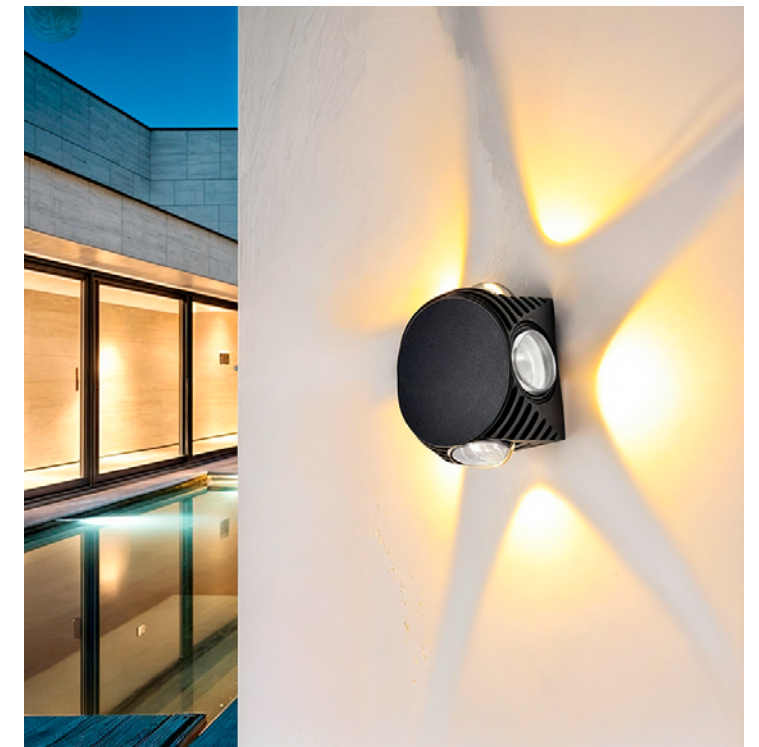

DIAMANTE | SURYA | PARÁBOLA



05-2509-*

Watts: 9W
 Lúmenes: 720lm
 TC: 3000K
 Voltaje: 127V
 CRI: >80
 IP: 65
 Ángulo Apertura: 100°
 Material: Aluminio + Cristal
 -03 Gris

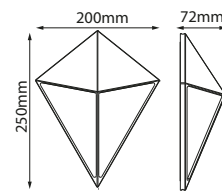

Tapa para registro:
 PR-0012-*

<input type="radio"/> -01 Blanco	<input type="radio"/> -03 Gris
<input type="radio"/> -04 Grafito	<input type="radio"/> -07 Negro

*Nota: Se venden por separado

CRETA | FLOAT | BRIK



05-7510-*

Watts: 10W
 Lúmenes: 828lm
 TC: 3000K
 Voltaje: 100-240V
 CRI: >80
 IP: 65
 Material: Concreto
 -11 Concreto

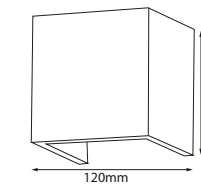

05-3223-*

Watts: 8W
 Lúmenes: 450lm
 TC: 3000K
 Voltaje: 110V
 CRI: >80
 IP: 54
 Material: Aluminio + Cristal
 -07 Negro

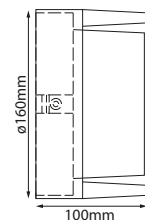

05-2271-*

Watts: 12W
 Lúmenes: 1000lm
 TC: 3000K
 Voltaje: 100-240V
 CRI: >80
 IP: 54
 Material: Aluminio + Cristal
 -04 Grafito

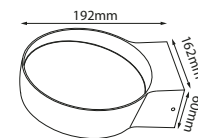

05-2061-*

Watts: 12W
 Lúmenes: 1000lm
 TC: 3000K
 Voltaje: 127V
 CRI: >80
 IP: 54
 Material: Aluminio + PC
 -01 Blanco -04 Grafito

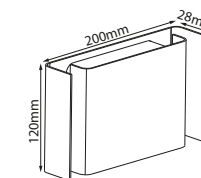

05-2616-*

Watts: 9W
 Lúmenes: 400lm
 TC: 3000K
 Voltaje: 110V
 CRI: >80
 IP: 54
 Material: Aluminio + Cristal
 -05 Bronce Rust

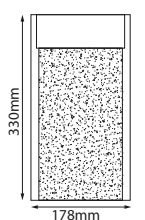

CLIO



05-2121-*

Watts: 9W
 Lúmenes: 950lm
 TC: 3000K
 Voltaje: 127V
 CRI: >80
 IP: 54
 Ángulo Apertura: 90°
 Material: Aluminio + PC

-04 Grafito

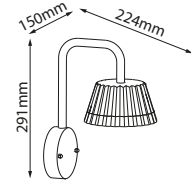

23-2123-*

Watts: 9W
 Lúmenes: 950lm
 TC: 3000K
 Voltaje: 127V
 CRI: >80
 IP: 54
 Ángulo Apertura: 90°
 Material: Aluminio + PC

-04 Grafito

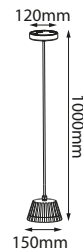

NIX | GAIA



*Colección NIX *Nota: Se venden por separado



05-2071-*

Watts: 12W
 Lúmenes: 700lm
 TC: 3000K
 Voltaje: 100-240V
 CRI: >80
 IP: 54
 Ángulo Apertura: 46°
 Material: Aluminio + Cristal

-03 Gris

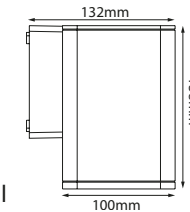

05-2072-*

Watts: 2*12W
 Lúmenes: 2*700lm
 TC: 3000K
 Voltaje: 100-240V
 CRI: >80
 IP: 54
 Ángulo Apertura: 46°
 Material: Aluminio + Cristal

-03 Gris

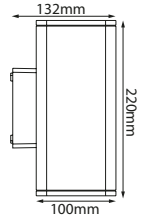

22-2073-*

Watts: 12W
 Lúmenes: 700lm
 TC: 3000K
 Voltaje: 100-240V
 CRI: >80
 IP: 54
 Ángulo Apertura: 46°
 Material: Aluminio + Cristal
 *A Techo

-03 Gris

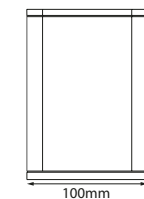

05-4820-*

Watts: 15W
 Lúmenes: 790lm
 TC: 3000K
 Voltaje: 100-240V
 CRI: >80
 IP: 54
 Ángulo Apertura: 120°
 Material: Aluminio + PC

-07 Negro

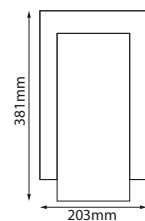

IRON | JUNO



05-2678-*

Watts: 10W
 Lúmenes: 730lm
 TC: 3000K
 Voltaje: 100-240V
 CRI: >90
 IP: 54
 Ángulo Apertura: 160°
 Material: Aluminio
 -07 Negro

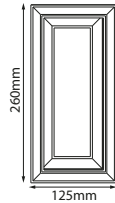

05-6410-*

Watts: 16W
 Lúmenes: 320lm
 TC: 3000K
 Voltaje: 100-240V
 CRI: >90
 IP: 54
 Ángulo Apertura: 120°
 Material: Aluminio
 -09 ABZ

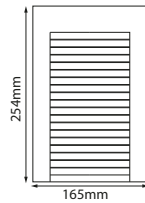

05-6216-*

Watts: 6W
 Lúmenes: 290lm
 TC: 3000K
 Voltaje: 100-240V
 CRI: >90
 IP: 54
 Material: Aluminio
 -04 Grafito



05-1001-*

Watts: 7W
 Lúmenes: 280lm
 TC: 3000K
 Voltaje: 100-240V
 CRI: >90
 IP: 65
 Material: Aluminio
 -01 Blanco -04 Grafito

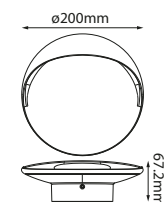

MEG | KRILL | VESTA



05-2942-*

Watts: 12W
 Lúmenes: 1000lm
 TC: 3000K
 Voltaje: 100-240V
 CRI: >80
 IP: 54
 Material: Aluminio
 -01 Blanco -04 Grafito

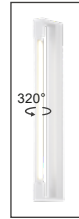
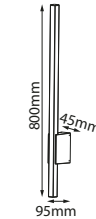

05-8238-*

Watts: 12W
 Lúmenes: 960lm
 TC: 3000K
 Voltaje: 100-240V
 CRI: >80
 IP: 44
 Material: Aluminio
 -01 Blanco -04 Grafito

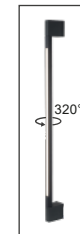

05-2551-*

Watts: 9W
 Lúmenes: 720lm
 TC: 3000K
 Voltaje: 100-240V
 CRI: >80
 IP: 54
 Ángulo Apertura: 102°
 Material: Aluminio
 -04 Grafito

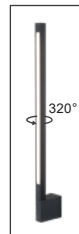

05-2552-*

Watts: 8W
 Lúmenes: 640lm
 TC: 3000K
 Voltaje: 100-240V
 CRI: >80
 IP: 54
 Ángulo Apertura: 102°
 Material: Aluminio
 -04 Grafito

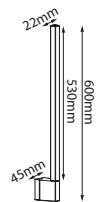

OUTDOOR PISO



NINFA | SMOOTH | CRETA



07-1701-*

Watts: 0.5W
 Lúmenes: 20lm
 TC: 3000K | 4000K | 5000K
 Voltaje: 90-130V
 CRI: >80
 IP: 67
 Ángulo Apertura: 30°
 Material: Aluminio + Cristal

-02 Satinado

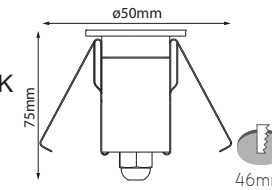

07-2721-*

Watts: 3.9W
 Lúmenes: 273lm
 TC: 3000K | 4000K
 Voltaje: 100-240V
 CRI: >80
 IP: 67
 Ángulo Apertura: 80°
 Material: Aluminio + Cristal

*Housing Acero

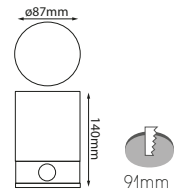

07-7053-*

Base: GU10
 Voltaje: 120V
 IP: 67
 Material: Aluminio + Cristal

-11 Concreto

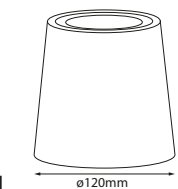

*Nota: Foco se vende por separado



TERRA II



07-1015-*

Watts: 1W
 Lúmenes: 80lm
 TC: 3000K
 Voltaje: 127V
 CRI: >80
 IP: 67
 Ángulo Apertura: 30°
 Material: Tapa SS316 + Cuerpo Aluminio

-08 Acero

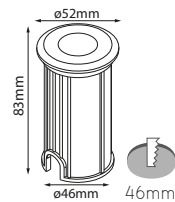

07-62100-*

Watts: 1W
 Lúmenes: 80lm
 TC: 3000K
 Voltaje: 127V
 CRI: >80
 IP: 67
 Ángulo Apertura: 45°
 Material: Tapa SS316 + Cuerpo Aluminio

-08 Acero

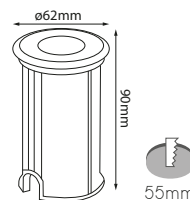

07-9201-*

Base: GU10
 Voltaje: 127V
 IP: 67
 Material: Tapa SS304 + Cuerpo Aluminio

-08 Acero

*Nota: Foco se vende por separado

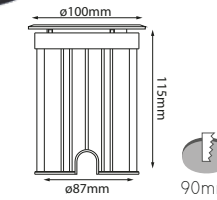

07-30100-*

Watts: 3W
 Lúmenes: 245lm
 TC: 3000K
 Voltaje: 127V / 60Hz
 CRI: >85
 IP: 67
 Ángulo Apertura: 45°
 Material: Tapa SS316 + Cuerpo Aluminio

-08 Acero

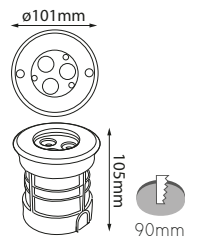

07-0301-*

Watts: 6W
 Lúmenes: 480lm
 TC: 3000K
 Voltaje: 127V / 60Hz
 CRI: >85
 IP: 67
 Ángulo Apertura: 35°
 Material: Tapa SS316 + Cuerpo Aluminio

-08 Acero

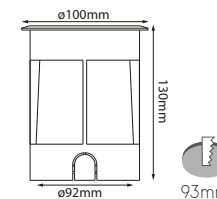

ATLANTIC



07-6201-10-*

Watts: 9W
 Lúmenes: 900lm
 TC: 3000K
 Voltaje: 100-240V
 CRI: >80
 IP: 67
 Ángulo Apertura: 20°
 Material: Tapa SS316 + Cuerpo Aluminio
 -08 Acero

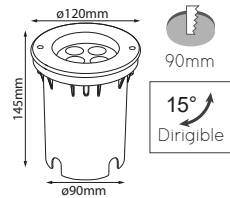

07-6201-*

Watts: 9W
 Lúmenes: 900lm
 TC: 3000K
 Voltaje: 100-240V
 CRI: >80
 IP: 67
 Ángulo Apertura: 45°
 Material: Tapa SS316 + Cuerpo Aluminio
 -08 Acero

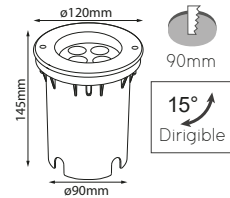

07-6401-10-*

Watts: 18W
 Lúmenes: 1710lm
 TC: 3000K
 Voltaje: 100-240V
 CRI: >80
 IP: 67
 Ángulo Apertura: 20°
 Material: Tapa SS316 + Cuerpo Aluminio
 -08 Acero



07-6401-*

Watts: 18W
 Lúmenes: 1710lm
 TC: 3000K
 Voltaje: 100-240V
 CRI: >80
 IP: 67
 Ángulo Apertura: 45°
 Material: Tapa SS316 + Cuerpo Aluminio
 -08 Acero

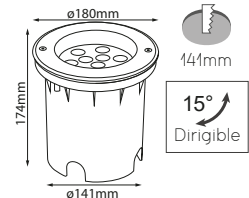

07-6301-10-*

Watts: 12W
 Lúmenes: 1140lm
 TC: 3000K
 Voltaje: 100-240V
 CRI: >80
 IP: 67
 Ángulo Apertura: 20°
 Material: Tapa SS316 + Cuerpo Aluminio
 -08 Acero

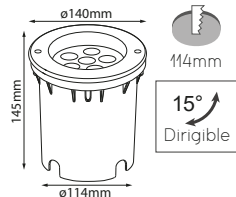

07-6301-*

Watts: 12W
 Lúmenes: 1140lm
 TC: 3000K
 Voltaje: 100-240V
 CRI: >80
 IP: 67
 Ángulo Apertura: 45°
 Material: Tapa SS316 + Cuerpo Aluminio
 -08 Acero

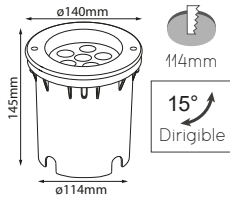

07-7301-*

Watts: 36W
 Lúmenes: 3600lm
 TC: 3000K
 Voltaje: 100-240V
 CRI: >80
 IP: 67
 Ángulo Apertura: 30°
 Material: Tapa SS316 + Cuerpo Aluminio
 -08 Acero

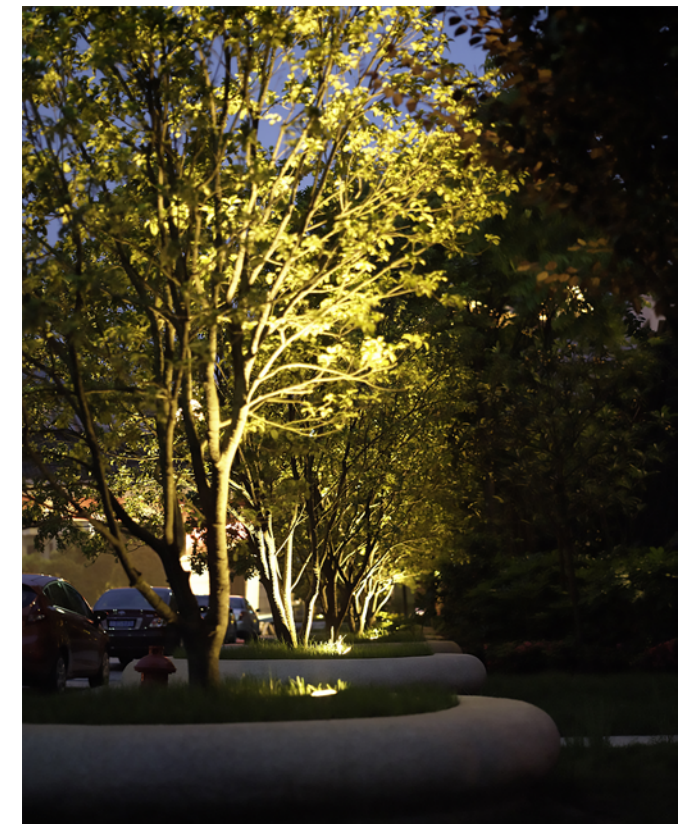
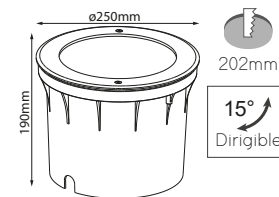

OCTOPUS

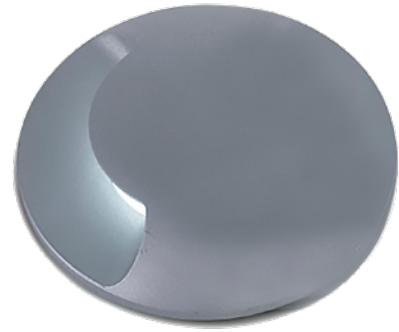

07-0061-*

Watts: 2.5W
 Lúmenes: 65lm
 TC: 3000K | 4000K
 Voltaje: 24V CD
 CRI: >80
 IP: 67
 Ángulo Apertura: 18°
 Material: Tapa SS316 + Cuerpo Aluminio
 *Soporta paso vehicular, IK08
 -08 Acero

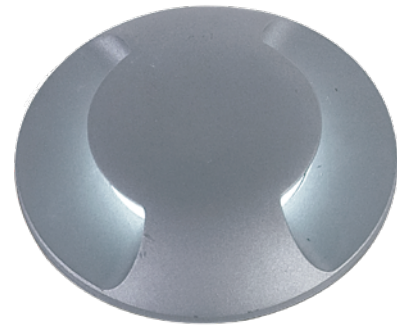
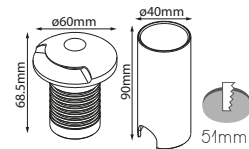

07-0062-*

Watts: 2.5W
 Lúmenes: 65lm
 TC: 3000K | 4000K
 Voltaje: 24V CD
 CRI: >80
 IP: 67
 Material: Tapa SS316 + Cuerpo Aluminio
 *Soporta paso vehicular, IK08
 -08 Acero

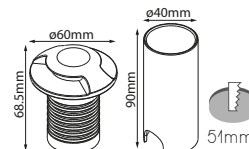

OCTOPUS III

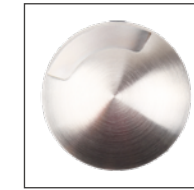

07-1011-*

Watts: 1W
 Lúmenes: 80lm
 TC: 3000K
 Voltaje: 110V CA
 CRI: >80
 IP: 67
 Material: Tapa SS316 + Cuerpo Aluminio
 -08 Acero

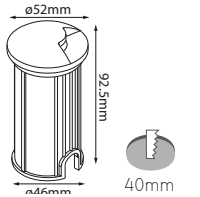

07-1012-*

Watts: 1W
 Lúmenes: 80lm
 TC: 3000K
 Voltaje: 110V CA
 CRI: >80
 IP: 67
 Material: Tapa SS316 + Cuerpo Aluminio
 -08 Acero

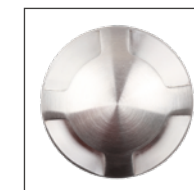
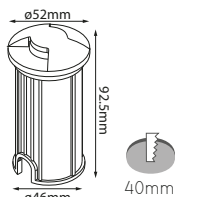

07-1014-*

Watts: 1W
 Lúmenes: 80lm
 TC: 3000K
 Voltaje: 110V CA
 CRI: >80
 IP: 67
 Material: Tapa SS316 + Cuerpo Aluminio
 -08 Acero

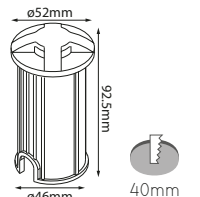

OCTOPUS II

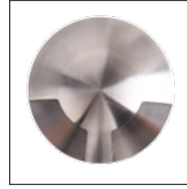

07-40921-*

Watts: 3W
 Lúmenes: 240lm
 TC: 3000K
 Voltaje: 100-240V
 CRI: >80
 IP: 67
 Material: Tapa SS316 + Cuerpo Aluminio
 -08 Acero

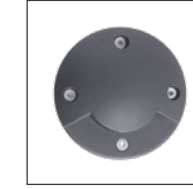
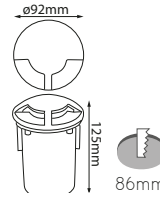

07-30011-*

Watts: 3W
 Lúmenes: 210lm
 TC: 3000K
 Voltaje: 100-240V
 CRI: >80
 IP: 67
 Material: Aluminio
 -04 Grafito

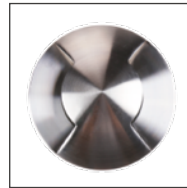
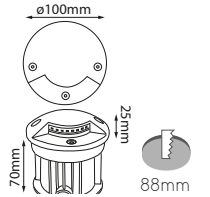

07-40922-*

Watts: 3W
 Lúmenes: 240lm
 TC: 3000K
 Voltaje: 100-240V
 CRI: >80
 IP: 67
 Material: Tapa SS316 + Cuerpo Aluminio
 -08 Acero

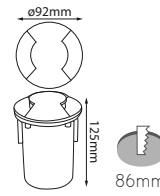

07-30012-*

Watts: 3W
 Lúmenes: 210lm
 TC: 3000K
 Voltaje: 100-240V
 CRI: >80
 IP: 67
 Material: Aluminio
 -04 Grafito

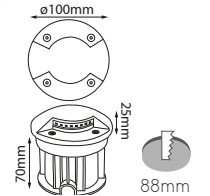

07-40926-*

Watts: 3W
 Lúmenes: 240lm
 TC: 3000K
 Voltaje: 100-240V
 CRI: >80
 IP: 67
 Material: Tapa SS316 + Cuerpo Aluminio
 -08 Acero

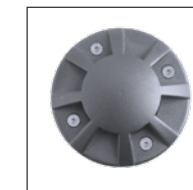
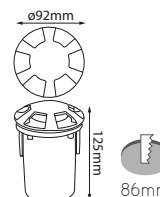

07-30016-*

Watts: 3W
 Lúmenes: 210lm
 TC: 3000K
 Voltaje: 100-240V
 CRI: >80
 IP: 67
 Material: Aluminio
 -04 Grafito

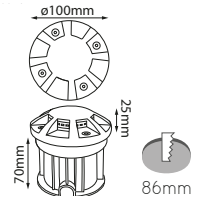

GEA



07-07300-*

Watts: 6W
 Lúmenes: 334lm
 TC: 3000K
 Voltaje: 100-240V
 CRI: >80
 IP: 67
 Ángulo Apertura: 45°
 Material: Tapa SS316 + Cuerpo Aluminio
 *Housing incluido
 -08 Acero

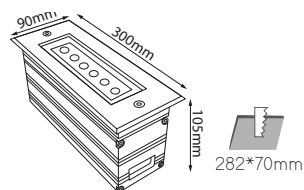

07-07601-*

Watts: 12W
 Lúmenes: 1117lm
 TC: 3000K
 Voltaje: 100-240V
 CRI: >80
 IP: 67
 Ángulo Apertura: 45°
 Material: Tapa SS316 + Cuerpo Aluminio
 *Housing incluido
 -08 Acero

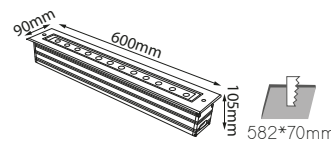

97-06300-*

Watts: 6W
 Lúmenes: 1265lm
 TC: 3000K
 Voltaje: 100-240V
 CRI: >80
 IP: 67
 Ángulo Apertura: 120°
 Material: Tapa SS316 + Cuerpo Aluminio
 *Housing incluido
 -08 Acero

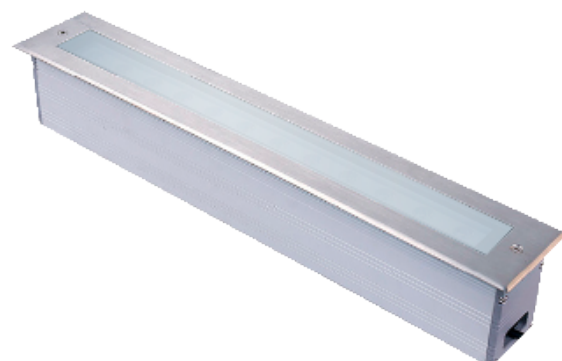
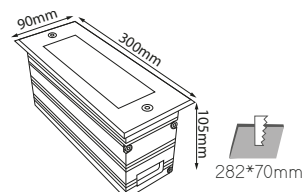

97-06601-*

Watts: 12W
 Lúmenes: 780lm
 TC: 3000K
 Voltaje: 100-240V
 CRI: >80
 IP: 67
 Ángulo Apertura: 120°
 Material: Tapa SS316 + Cuerpo Aluminio
 *Housing incluido
 -08 Acero

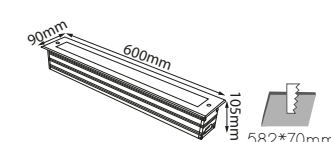

SPIKE LIGHTS



ONDINA MINI | ONDINA



05-9105-*

Watts: 5W
 Lúmenes: 420lm
 TC: 3000K | 4000K | 5000K
 Voltaje: 90-130V
 CRI: >80
 IP: 65
 Ángulo Apertura: 32°
 Material: Aluminio

07 Negro



05-9205-*

Watts: 5W
 Lúmenes: 400lm
 TC: 3000K | 6000K
 Voltaje: 90-130V
 CRI: >80
 IP: 65
 Ángulo Apertura: 30°
 Material: Aluminio

07 Negro

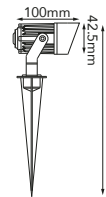

03-4901-*

Watts: 6W
 Lúmenes: 450lm
 TC: 3000K | 4000K
 Voltaje: 127V
 CRI: >80
 IP: 65
 Ángulo Apertura: 48°
 Material: Aluminio

04 Grafito

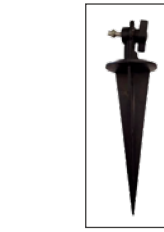

*Estaca SP-034901

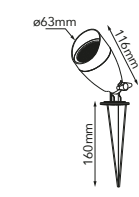

03-9003-*

Watts: 5W
 Lúmenes: 420lm
 TC: 3000K
 Voltaje: 100-240V
 CRI: >80
 IP: 65
 Ángulo Apertura: 38°
 Material: Plástico

07 Negro

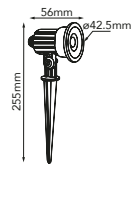

*Nota: Driver y estaca incluidos



Accesorio Estaca



12-2101-*

03-4801-*

Base: GU10
 Voltaje: 127V
 IP: 54
 Material: Aluminio

04 Grafito

*Nota: Foco se vende por separado



CAP-05-9106
 *Se vende por separado



Accesorio Estaca



12-2101-*

05-9106-*

Watts: 10W
 Lúmenes: 800lm
 TC: 3000K | 4000K
 Voltaje: 100-240V
 CRI: >80
 IP: 65
 Ángulo Apertura: 30°
 Material: Aluminio

04 Grafito

*Nota: Driver y estaca incluidos

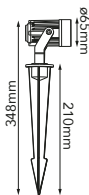

03-9005-GU-*

Base: GU10
 Voltaje: 100-240V
 IP: 65
 Material: Plástico

07 Negro

*Nota: Foco se vende por separado.

*Estaca incluida

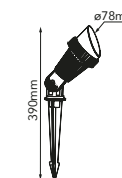

03-9101-E2-*

Base: E26
 Voltaje: 100-240V
 IP: 65
 Material: Plástico

07 Negro

*Nota: Foco se vende por separado

*Estaca incluida

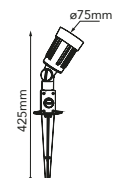

MOON | LIBRA

**10-2351-***

Watts: 6W
 Lúmenes: 620lm
 TC: 3000K
 Voltaje: 100-240V
 CRI: >80
 IP: 65
 Ángulo Apertura: 350°
 Material: Aluminio

04 Grafito

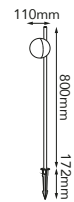
**10-2352-***

Watts: 2*6W
 Lúmenes: 2*620lm
 TC: 3000K
 Voltaje: 100-240V
 CRI: >80
 IP: 65
 Ángulo Apertura: 2*350°
 Material: Aluminio

04 Grafito

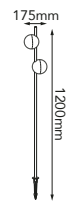

DIANA | CLIO | JIÁ | ORTHOS

**05-3505-***

Watts: 5W
 Lúmenes: 400lm
 TC: 6000K
 Voltaje: 100-240V
 CRI: >80
 IP: 65
 Ángulo Apertura: 38°
 Material: Plástico

07 Negro

*Nota: Driver y estaca incluidos

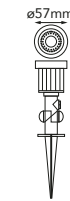
**10-2122-***

Watts: 9W
 Lúmenes: 950lm
 TC: 3000K
 Voltaje: 100-240V
 CRI: >80
 IP: 65
 Ángulo Apertura: 85°
 Material: Aluminio

04 Grafito

*Nota: Driver y estaca incluidos

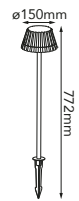
**10-2531-***

Watts: 3W
 Lúmenes: 240lm
 TC: 3000K
 Voltaje: 100-240V
 CRI: >80
 IP: 65
 Material: Acero Inoxidable + PC

04 Grafito

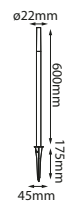
**10-2553-***

Watts: 8W
 Lúmenes: 640lm
 TC: 3000K
 Voltaje: 100-240V
 CRI: >80
 IP: 65
 Material: Aluminio + PC

04 Grafito

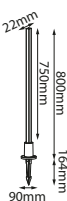
**10-2492-***

Watts: 7W
 Lúmenes: 500lm
 TC: 3000K
 Voltaje: 100-240V
 CRI: >80
 IP: 65
 Ángulo Apertura: 220°
 Material: Aluminio

04 Grafito

*Nota: Driver y estaca incluidos



Base y Estaca incluidos

**10-4801-***

Base: 2*GU10
 Voltaje: 100-240V
 IP: 65
 Material: Aluminio

04 Grafito

*Nota: Driver y estaca incluidos

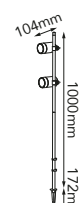

*Nota: Driver y estaca incluidos

BALIZAS

PHARO | ORION

**10-1071-***

Watts: 1W
 Lúmenes: 60lm
 TC: 6000K
 Voltaje: 100-240V
 CRI: >80
 IP: 67
 Ángulo Apertura: 350°
 Material: Aluminio

-03 Gris

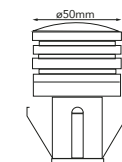
**55-9107-***

Watts: 3W
 Lúmenes: 330lm
 TC: 3000K
 Voltaje: 100-240V
 CRI: >80
 IP: 54
 Ángulo Apertura: 93°
 Material: Aluminio

-03 Gris

**10-2704-***

Watts: 7W
 Lúmenes: 630lm
 TC: 3000K
 Voltaje: 100-240V
 CRI: >80
 IP: 65
 Material: Aluminio
 *Driver IP65

-04 Grafito

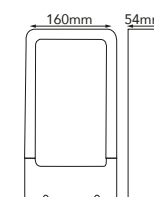
**55-2704-***

Watts: 7W
 Lúmenes: 630lm
 TC: 3000K
 Voltaje: 100-240V
 CRI: >80
 IP: 65
 Material: Aluminio
 *Driver IP65

-04 Grafito



*Nota: Driver incluido

CAGE



10-1932-*

Watts: 12W
 Lúmenes: 700lm
 TC: 3000K
 Voltaje: 100-240V
 CRI: >80
 IP: 54
 Ángulo Apertura: 125°
 Material: Aluminio
 -05 Bronce Rust

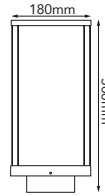

55-1933-*

Watts: 12W
 Lúmenes: 700lm
 TC: 3000K
 Voltaje: 100-240V
 CRI: >80
 IP: 54
 Ángulo Apertura: 125°
 Material: Aluminio
 -05 Bronce Rust

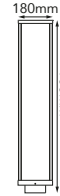

HADES | POLARIS

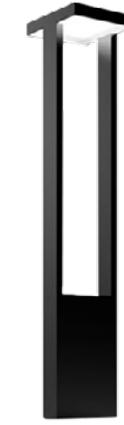

10-2522-*

Watts: 14W
 Lúmenes: 1120lm
 TC: 3000K
 Voltaje: 100-240V
 CRI: >80
 IP: 65
 Ángulo Apertura: 290°
 Material: Aluminio
 -04 Grafito

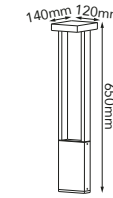

10-2091-*

Watts: 9W
 Lúmenes: 500lm
 TC: 3000K
 Voltaje: 100-240V
 CRI: >80
 IP: 54
 Material: Aluminio
 *Driver IP65
 -04 Grafito

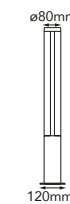

55-2091-*

Watts: 27W
 Lúmenes: 1290lm
 TC: 3000K
 Voltaje: 100-240V
 CRI: >80
 IP: 54
 Material: Aluminio
 *Driver IP65
 -04 Grafito

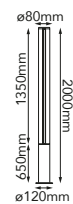

*Nota: Driver incluido

*Nota: Driver incluido

ÍCARO | TORCH



55-2773-*

Watts: 22W
Lúmenes: 1850lm
TC: 3000K
Voltaje: 100-240V
CRI: >80
IP: 65
Ángulo Apertura: 144°
Material: Aluminio

-04 Grafito

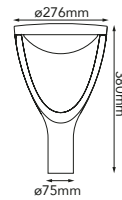

50-0070-*

Watts: 70W
Lúmenes: 8400lm
TC: 5000K
Voltaje: 100-277V
CRI: >80
IP: 65
Ángulo Apertura: 120°
Material: Aluminio

*IK08

-03 Gris

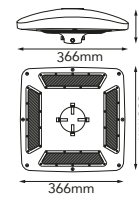

*Nota: Fococelda incluida



10-2103-*

Base: E26
Voltaje: 127V
IP: 65
Material: Aluminio

-04 Grafito

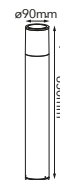

*Nota: Sugerencia de uso foco 45-1004 | 45-2604

*Se venden por separado

REFLECTORES



MEDUSA | MEG | COSMOS

LUMI-THOR

90-3201-*

Watts: 9W
Lúmenes: 900lm
TC: 3000K
Voltaje: 100-240V
CRI: >80
IP: 65
Ángulo Apertura: 24°*45°
Material: Aluminio + Cristal Templado
-03 Gris

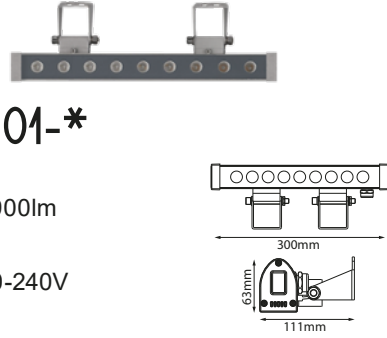

90-3202-*

Watts: 24W
Lúmenes: 2100lm
TC: 3000K | 4000K
Voltaje: 100-240V
CRI: >80
IP: 65
Ángulo Apertura: 45°
Material: Aluminio + Cristal Templado
-03 Gris

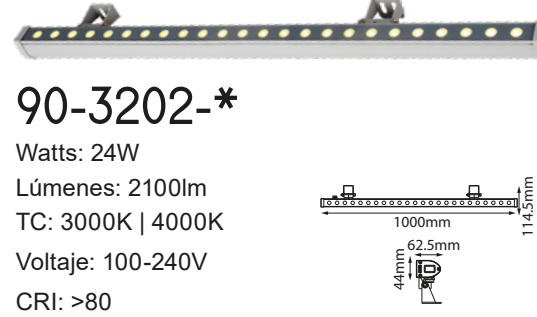

90-3001-*

Watts: 11W
Lúmenes: 700lm
TC: 3000K | 4000K
Voltaje: 24V CD
CRI: >80
IP: 67
Ángulo Apertura: 120°
Material: Aluminio + Cristal Templado
*Requiere fuente de poder
-03 Gris

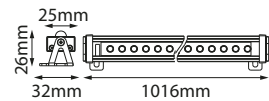

90-2943-*

Watts: 15W
Lúmenes: 1500lm
TC: 3000K
Voltaje: 100-240V
CRI: >80
IP: 65
Ángulo Apertura: 85°
Material: Aluminio + Cristal Templado
-04 Grafito

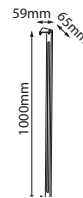

05-0010-*

Watts: 10W
Lúmenes: 800lm
TC: 3000K | 5000K
Voltaje: 100-130V
CRI: >80
IP: 65
Ángulo Apertura: 120°
Material: Aluminio + Cristal Templado
-07 Negro

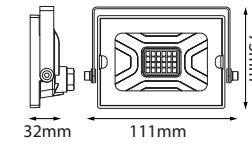

05-0020-*

Watts: 20W
Lúmenes: 1600lm
TC: 3000K | 5000K
Voltaje: 100-130V
CRI: >80
IP: 65
Ángulo Apertura: 120°
Material: Aluminio + Cristal Templado
-07 Negro

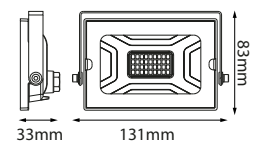

05-0030-*

Watts: 30W
Lúmenes: 2400lm
TC: 3000K | 5000K
Voltaje: 100-130V
CRI: >80
IP: 65
Ángulo Apertura: 120°
Material: Aluminio + Cristal Templado
-07 Negro

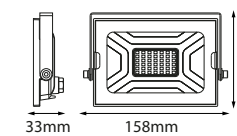

05-0050-*

Watts: 50W
Lúmenes: 4000lm
TC: 3000K | 5000K
Voltaje: 100-130V
CRI: >80
IP: 65
Ángulo Apertura: 120°
Material: Aluminio + Cristal Templado
-07 Negro

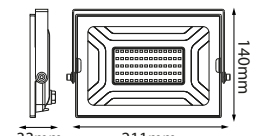

5-21301-*

Watts: 150W
Lúmenes: 18000lm
TC: 4100K
Voltaje: 100-240V
CRI: >80
IP: 65
Ángulo Apertura: 30°
Material: Aluminio + Cristal Templado
-03 Gris



*Nota: Driver incluido, 50cm de Cable

LUMI-THOR



5-25250-*

Watts: 210W
 Lúmenes: 16352lm
 TC: 3000K | 5000K
 Voltaje: 85-265V
 CRI: >80
 IP: 65
 Ángulo Apertura: 102°
 Material: Aluminio + Cristal Templado

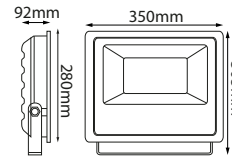

07 Negro



05-3500-*

Watts: 500W
 Lúmenes: 45000lm
 TC: 5000K
 Voltaje: 85-265V
 CRI: >80
 IP: 65
 Ángulo Apertura: 102°
 Material: Aluminio + Cristal Templado

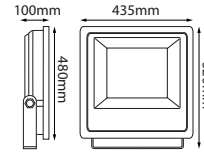

07 Negro



5-25100-*

Watts: 100W
 Lúmenes: 8000lm
 TC: 3000K | 5000K
 Voltaje: 100-130V
 CRI: >80
 IP: 65
 Ángulo Apertura: 120°
 Material: Aluminio + Cristal Templado

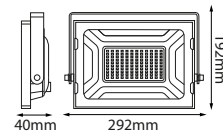

07 Negro



5-25400-*

Watts: 400W
 Lúmenes: 30000lm
 TC: 3000K
 Voltaje: 100-130V
 CRI: >80
 IP: 65
 Ángulo Apertura: 120°
 Material: Aluminio + Cristal Templado

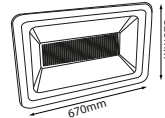

*Nota: Driver incluido

SUBACUÁTICAS



*Nota: Driver incluido

NINFA | HYDRA

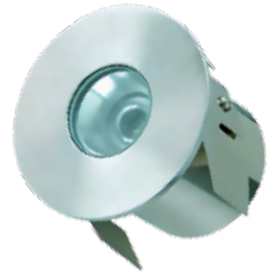

07-1707-*

Watts: 1W
 Lúmenes: 40lm
 TC: 3000K
 Voltaje: 12V AC/DC
 CRI: >80
 IP: 68
 Ángulo Apertura: 30°
 Material: Aluminio + Cristal

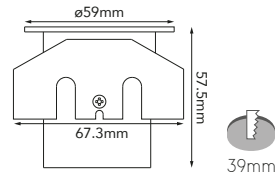

77-4703-*

Watts: 12W
 Lúmenes: 960lm
 TC: 3000K | 4000K | 5000K
 Voltaje: 24V CD
 CRI: >80
 IP: 68
 Ángulo Apertura: 60°
 Material: Acero SS316
 *Housing Incluido, Cable 5m
 -08 Acero

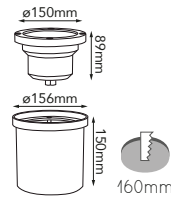

HYDROX | TERRA II | DELTA



07-4051-*

Watts: 6W
 Lúmenes: 420lm
 TC: 3000K | 4000K
 Voltaje: 24V CD
 CRI: >80
 IP: 68
 Ángulo Apertura: 30°
 Material: Acero SS316
 -08 Acero

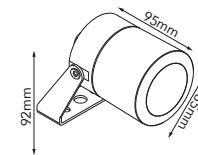

07-62024-*

Watts: 1W
 Lúmenes: 106lm
 TC: 3000K
 Voltaje: 24V CD
 CRI: >80
 IP: 68
 Ángulo Apertura: 50°
 Material: Aluminio + Tapa SS316
 -08 Acero

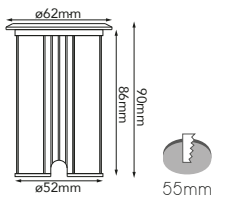

77-0391-*

Watts: 9W
 Lúmenes: 720lm
 TC: 3000K | 5000K
 Voltaje: 24V CD
 CRI: >80
 IP: 68
 Ángulo Apertura: 45°
 Material: Acero SS316
 -08 Acero

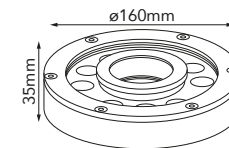

77-0306-*

Watts: 6W
 Lúmenes: 412lm
 TC: 3000K | 5000K
 Voltaje: 24V CD
 CRI: >80
 IP: 68
 Ángulo Apertura: 45°
 Material: Acero SS316
 -08 Acero

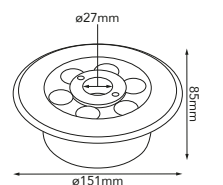

*NOTA: Requiere transformador 24V CD. Uso exclusivo bajo el agua.

*NOTA: Requiere transformador. Uso exclusivo bajo el agua.

RGB

NINFA | ONDINA | TERRA | DELTA



07-1701-RGB

Watts: 0.5W
 TC: Cambio de Color RGB
 Voltaje: 12V CD
 IP: 67
 Ángulo Apertura: 30°
 Material: Aluminio + Tapa SS316
 -02 Satinado

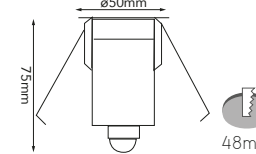

05-0901-RGB

Watts: 4W
 TC: Cambio de Color RGB
 Voltaje: 12V CD
 IP: 67
 Ángulo Apertura: 35°
 Material: Aluminio

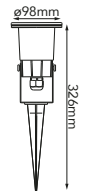

*NOTA: Estaca se vende por separado



77-0393-RGB

Watts: 31W
 TC: Cambio de Color RGB
 Voltaje: 24V CD
 IP: 68
 Ángulo Apertura: 45°
 Material: Acero SS316
 -08 Acero

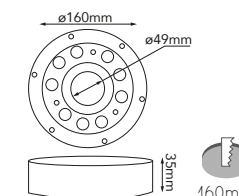

07-0301-RGB

Watts: 6W
 TC: Cambio de Color RGB
 Voltaje: 12V CD
 IP: 67
 Ángulo Apertura: 45°
 Material: Aluminio + Tapa SS316
 -08 Acero

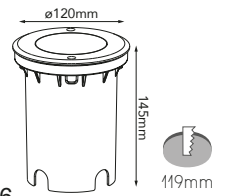

*NOTA: Controlador y Fuente de Poder se venden por separado

ATLANTIC | HYDRA II



07-6301-RGB

Watts: 12W
 TC: Cambio de Color RGB
 Voltaje: 12V CD
 IP: 67
 Ángulo Apertura: 45°
 Material: Aluminio + Tapa SS316
 -08 Acero

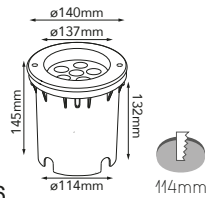

07-6401-RGB

Watts: 18W
 TC: Cambio de Color RGB
 Voltaje: 12V CD
 IP: 67
 Ángulo Apertura: 45°
 Material: Aluminio + Tapa SS316
 -08 Acero

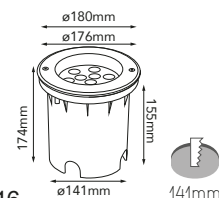

05-0502-RGB

Watts: 20W
 TC: Cambio de Color RGB
 Voltaje: 24V CD
 IP: 65
 Ángulo Apertura: 45°*25°
 Material: Aluminio



90-2501-RGB

Watts: 32W
 TC: Cambio de Color RGB
 Voltaje: 24V CD
 IP: 65
 Ángulo Apertura: 45°
 Material: Aluminio

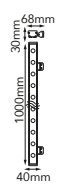

77-6013-RGB

Watts: 3W
 TC: Cambio de Color RGB
 Voltaje: 12V CD
 IP: 68
 Ángulo Apertura: 60°
 Material: Aluminio + Tapa SS316
 -08 Acero

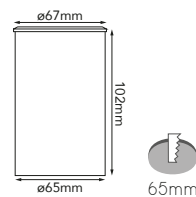

77-6015-RGB

Watts: 5W
 TC: Cambio de Color RGB
 Voltaje: 12V CD
 IP: 68
 Ángulo Apertura: 60°
 Material: Aluminio + Tapa SS316
 -08 Acero

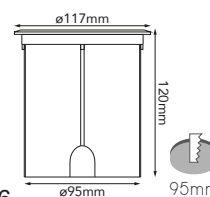

90-3001-RGB

Watts: 11.5W
 TC: Cambio de Color RGB
 Voltaje: 24V CD
 IP: 67
 Ángulo Apertura: 120°
 Material: Aluminio

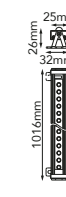

77-4703-RGB

Watts: 17W
 TC: Cambio de Color RGB
 Voltaje: 24V CD
 IP: 68
 Ángulo Apertura: 15°
 Material: Acero SS316
 *Housing Incluido, Cable 5m
 -08 Acero

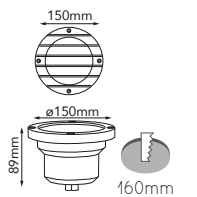

*NOTA: Controlador y Fuente de Poder se venden por separado

*NOTA: Controlador y Fuente de Poder se venden por separado

MEDUSA II

Accesorio:

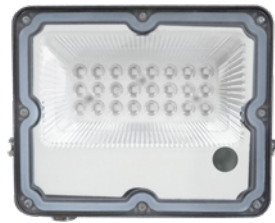

5-3620-RGB

Watts: 7W
 Lúmenes: 1600lm
 TC: Cambio de Color RGB
 Voltaje: 100-265V
 CRI: >80
 IP: 65
 Ángulo Apertura: 120°
 Material: Aluminio
 -03 Gris

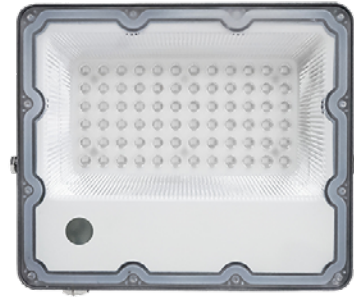
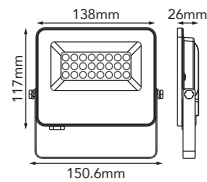

5-3650-RGB

Watts: 17W
 Lúmenes: 4000lm
 TC: Cambio de Color RGB
 Voltaje: 100-265V
 CRI: >80
 IP: 65
 Ángulo Apertura: 120°
 Material: Aluminio
 -03 Gris

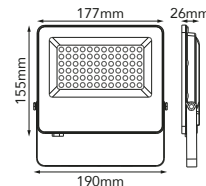

COSMOS II | EVA



5-21101-RGB

Watts: 50W
 TC: Cambio de Color RGB
 Voltaje: 100-240V
 CRI: >80
 IP: 65
 Ángulo Apertura: 30°
 Material: Aluminio
 -03 Gris

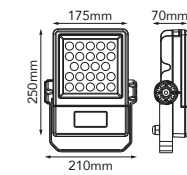

5-21201-RGB

Watts: 100W
 TC: Cambio de Color RGB
 Voltaje: 100-240V
 CRI: >80
 IP: 65
 Ángulo Apertura: 30°
 Material: Aluminio
 -03 Gris

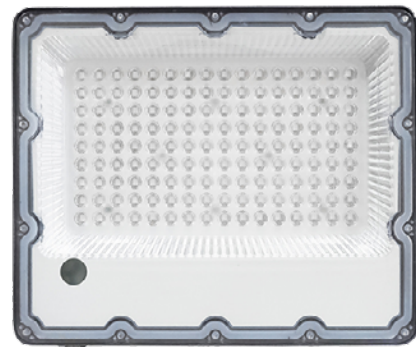
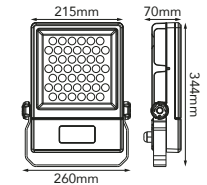

5-36100-RGB

Watts: 33W
 Lúmenes: 8000lm
 TC: Cambio de Color RGB
 Voltaje: 100-265V
 CRI: >80
 IP: 65
 Ángulo Apertura: 120°
 Material: Aluminio
 -03 Gris

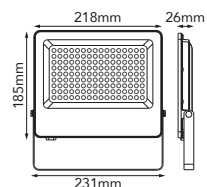

5-36150-RGB

Watts: 50W
 Lúmenes: 1200lm
 TC: Cambio de Color RGB
 Voltaje: 100-265V
 CRI: >80
 IP: 65
 Ángulo Apertura: 120°
 Material: Aluminio
 -03 Gris

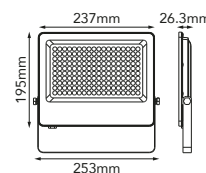

55-4021-RGBW

Watts: 15W
 TC: Cambio de Color RGB
 Voltaje: 127V
 IP: 65
 Material: Aluminio
 -04 Grafito

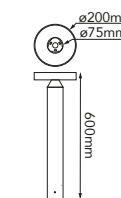

*Bluetooth y tuya smart app

*NOTA: Controlador se vende por separado

INDUSTRIAL

OYSTER | PARIS

**22-0210-***

Base: G13. 2 * Tubo T8

IP: 65

Material: Aluminio + PC

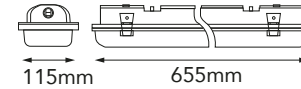
**22-0218-***

Base: G13. 2 * Tubo T8

IP: 65

Material: Aluminio + PC

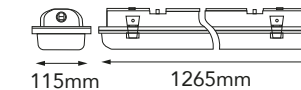
**27-4001-40**

Watts: 50W

Lúmenes: 4000lm

TC: 4000K

Voltaje: 90-260V

CRI: >80

IP: 65

Ángulo Apertura: 120°

Material: Aluminio + PC

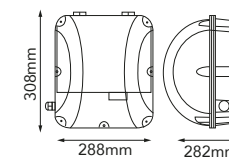
***NOTA: Fococelda se vende por separado**

HI-BAY | UFO

9 Formas de Iluminar tu Espacio

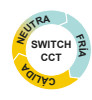

Switc Cambio CCT y Watts



Control Remoto HD06R



SENSOR HD06VCRH 7B

20-1150-3TC

Watts: SW 80W | 100W | 150W
Lúmenes: SW 12000 | 15000 | 22500lm
SW CCT: 3000K | 4000K | 5000K

Voltaje: 120-277V

CRI: >80

IP: 65

Ángulo Apertura: 90°

Material: Aluminio + PC

-07 Negro

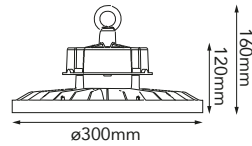

**NOTA: Sensor Kit y control se vende por separado*



20-9080-40/65

Watts: 80W
Lúmenes: 7500lm
TC: 4000K | 6000K
Voltaje: 85-265V
CRI: >80
IP: 65
Ángulo Apertura: 90°
Material: Aluminio

-03 Gris

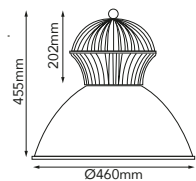

20-3110-*

Watts: 100W
Lúmenes: 1000lm
TC: 5000K
Voltaje: 110-240V
CRI: >80
IP: 65
Ángulo Apertura: 180°
Material: Aluminio + PC

-07 Negro

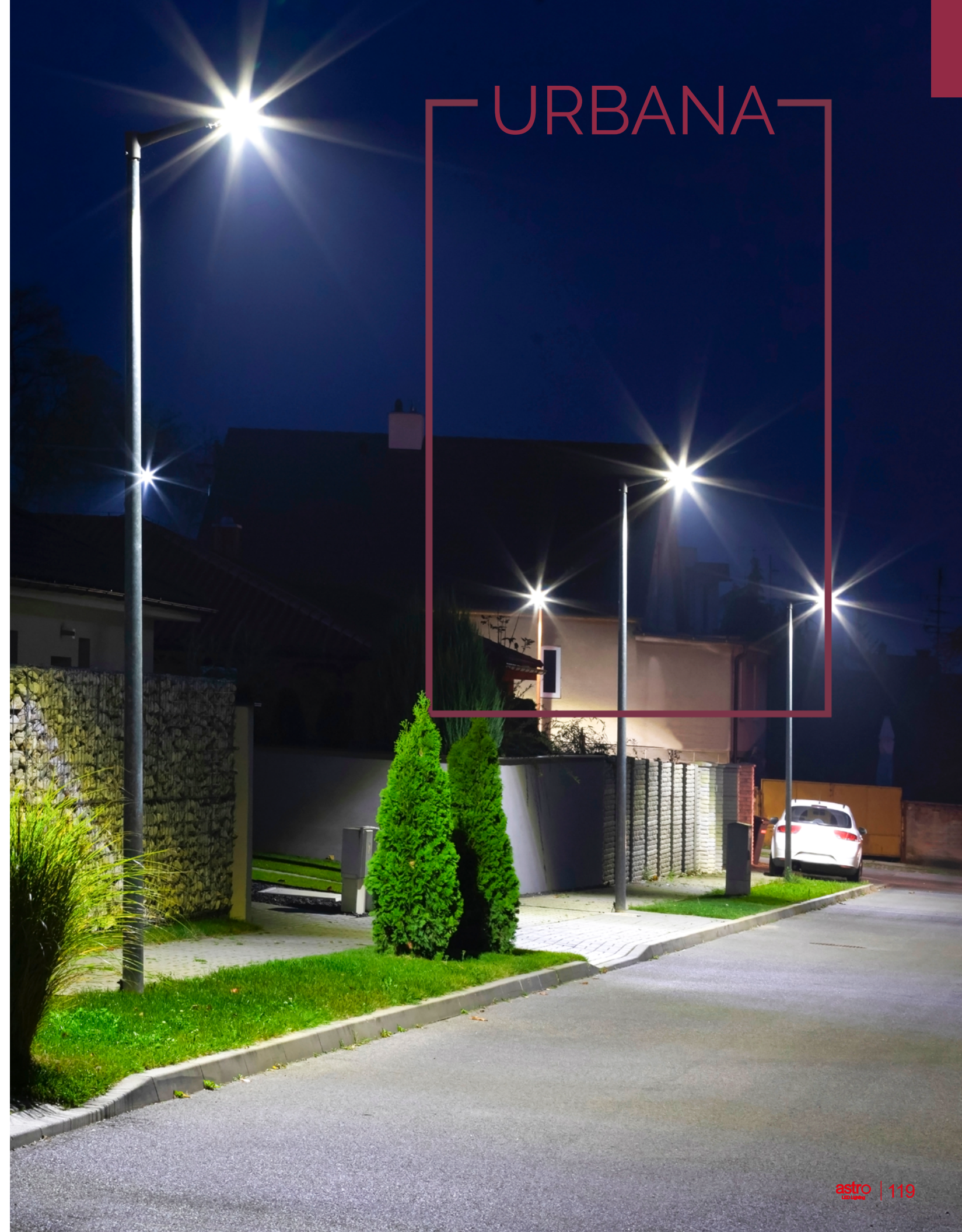
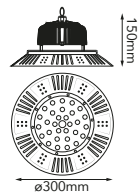

URBANA

URBANA



15-0050-65

Watts: 50W
 Lúmenes: 4500lm
 TC: 6000K
 Voltaje: 90-260V
 CRI: >80
 IP: 65
 Ángulo Apertura: 80°*140°
 Material: Aluminio+Cristal Templado
 -03 Gris

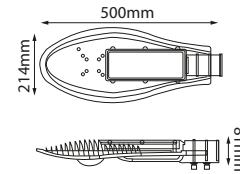

15-0100-65

Watts: 100W
 Lúmenes: 9000lm
 TC: 6000K
 Voltaje: 90-260V
 CRI: >80
 IP: 65
 Ángulo Apertura: 80°*140°
 Material: Aluminio+Cristal Templado
 -03 Gris

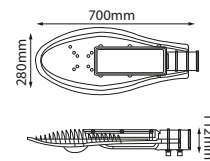

15-0150-65

Watts: 150W
 Lúmenes: 13500lm
 TC: 6000K
 Voltaje: 90-260V
 CRI: >80
 IP: 65
 Ángulo Apertura: 80°*140°
 Material: Aluminio+Cristal Templado
 -03 Gris

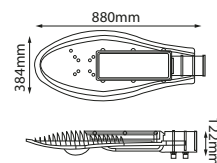

SOLARES



CLIP | IRIS | CAGE | ONDINA



01-30605-*

Watts: 4W
 Lúmenes: 900lm
 TC: 6500K
 CRI: >80
 IP: 65
 Ángulo Apertura: 120°
 Material: ABS+PC, anti UV
 Rango de Sensor PIR: Ángulo de detección: 120°
 Área de detección: ≤4M
 Altura instalación: ≤2M
 Tiempo de Carga: 8 horas de luz solar directa
 Horas de Trabajo: Hasta 10 horas
 Batería: Batería Litio 18650, 3.7V, 1500mAh

07 Negro

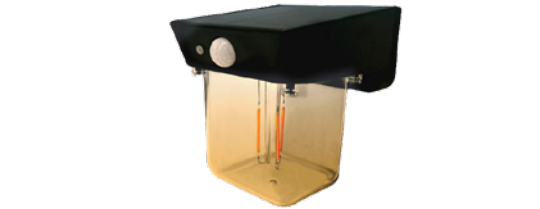
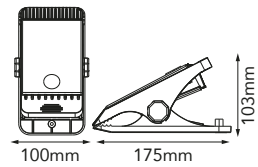

05-2016-*

Watts: 2W
 Lúmenes: 190lm
 TC: 3000K
 CRI: >80
 IP: 65
 Ángulo Apertura: 120°
 Material: ABS+PC
 Rango de Sensor PIR: Ángulo de detección: 120°
 Área de detección: ≤4.5M
 Altura instalación: ≤4M
 Tiempo de Carga: 6 - 8 horas de luz solar directa
 Horas de Trabajo: Hasta 10 horas
 Batería: Batería Litio 18650, 3.7V, 1500mAh

07 Negro

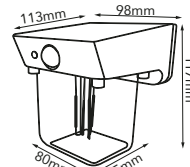

40-2104-*

Watts: 4W
 Lúmenes: 500lm
 TC: 3000K | 4000K
 CRI: >80
 IP: 65
 Ángulo Apertura: 90°
 Material: ABS+PC, anti UV
 Rango de Sensor PIR: 120°, 2-6 metros
 Altura Instalación: 2-4 metros
 Tiempo de Carga: 12-15 horas para carga completa
 Modo Sensor: más de 35 horas
 Modo Mantener Encendido: más de 30 horas
 Batería: 18650, 3.7V, 2000mAh, 7.4Wh (Reemplazable)

01 Blanco 07 Negro

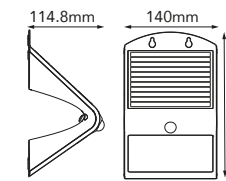

BUTTERFLY



40-2115-*

Watts: 1.5W
 Lúmenes: 220lm
 TC: 3000K | 4000K
 CRI: >80
 IP: 65
 Ángulo Apertura: 90°
 Material: ABS+PC, anti UV
 Rango de Sensor PIR: 120°, < 6 metros
 Altura Instalación: 4 metros
 Tiempo de Carga: 6 - 8 horas de luz solar directa
 Modo Sensor: más de 35 horas
 Modo Mantener Encendido: más de 30 horas
 Batería: 1200mAh / 3.7V. Reemplazable

01 Blanco 07 Negro

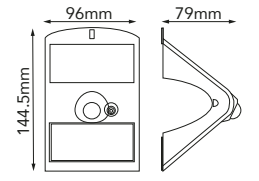

10-3341-*

Watts: 2W
 Lúmenes: 190lm
 TC: 3000K
 CRI: >80
 IP: 54
 Ángulo Apertura: 90°
 Material: Aluminio
 Tiempo de Carga: 5 horas con adaptador
 6-10 horas con luz solar
 Horas de Trabajo: Hasta 10 - 12 horas
 Batería: 2*2200mAh, 3.7V. Reemplazable

04 Grafito

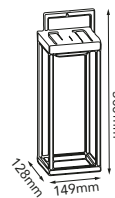

03-2012-*

Watts: 2W
 Lúmenes: 190lm
 TC: 3000K | 4000K
 CRI: >80
 IP: 54
 Ángulo Apertura: 120°
 Material: ABS+PC
 Tiempo de Carga: 5 - 10 horas con luz solar
 Horas de Trabajo: Hasta 10 - 12 horas
 Distancia instalación: ≤3M
 Batería: Batería Litio 18650, 3.7V, 1500mAh

07 Negro

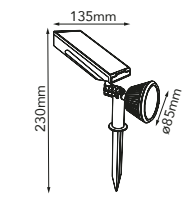

BLOC | GIRO



Sensor de Movimiento

40-2303-*

Watts: 3W
 Lúmenes: 350lm
 TC: 3000K
 CRI: >80
 IP: 65
 Ángulo Apertura: 120° * 60°
 Material: ABS+PC, anti UV
 Rango de Sensor PIR: 120°, < 6 metros
 Altura Instalación: 2-4 metros
 Tiempo de Carga: 5 - 6 horas con luz solar directa
 Horas de Trabajo: Hasta 35 horas
 Batería: 18650, 3.7V, 1200mAh, 4.44Wh
 -01 Blanco -07 Negro

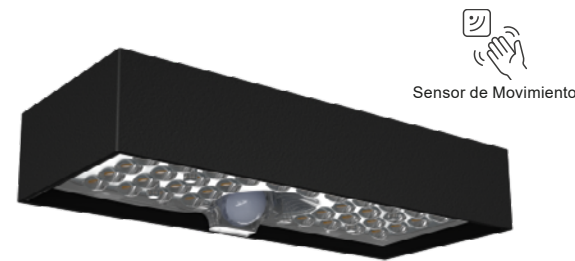
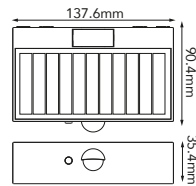

Sensor de Movimiento

40-2306-*

Watts: 5W
 Lúmenes: 900lm
 TC: 3000K
 CRI: >80
 IP: 65
 Ángulo Apertura: 120° * 60°
 Material: ABS+PC, anti UV
 Rango de Sensor PIR: 120°, < 6 metros
 Altura Instalación: ≤ 4 metros
 Tiempo de Carga: 8 - 10 horas con luz solar directa
 Horas de Trabajo: Modo A: 4 noches+ / Modo B: 2 noches+
 Batería: 18650, 3.7V, 1200mAh, 4.44Wh
 -01 Blanco -07 Negro

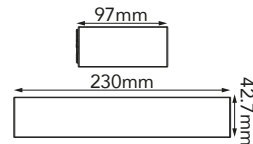

Sensor de Movimiento

40-2608-*

Watts: 8W
 Lúmenes: 950lm
 TC: 4000K
 CRI: >80
 IP: 65
 Material: ABS+PC
 Rango de Sensor PIR: Ángulo de detección: 120°
 Área de detección: ≤8M
 Tiempo de Carga: 5 - 6 horas de luz solar directa
 Horas de Trabajo: Modo A: de 3 a 5 Noches
 Modo B: de 2 a 3 Noches
 -07 Negro

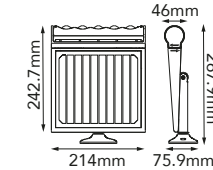

3 Aplicaciones



7 Instalaciones



52-4020-*

Watts: 20W
 Lúmenes: 2100lm
 TC: 3000K | 4000K
 CRI: >80
 IP: 65
 Ángulo Apertura: 360°
 Material: ABS+PC, anti UV
 Tiempo de Carga: 4-6 horas para carga completa
 Horas de Trabajo: 32 horas
 Altura Instalación: 2-4 metros
 Distancia Instalación: 8m a 12m entre luminarias
 Batería: 6000mAh / 6.4V. Reemplazable
 -07 Negro

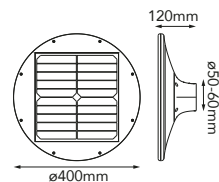

Sensor de Movimiento

40-2015-*

Watts: 15W
 Lúmenes: 2000lm
 TC: 3000K | 4000K
 CRI: >80
 IP: 65
 Ángulo Apertura: 95° * 85°
 Material: ABS+PC, anti UV
 Rango de Sensor PIR: Área 80m²
 Altura Instalación: 2-4 metros
 Tiempo de Carga: 5 - 6 horas de luz solar directa
 Horas de Trabajo: Hasta 80 horas
 Batería: 32700, 3.2V, 6000mAh, 19.2Wh
 -07 Negro

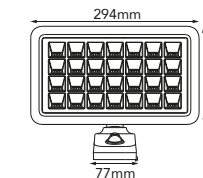

10-4010-*

Watts: 10W
 Lúmenes: 1000lm
 SW CCT: 3000K | 4000K | 6000K
 CRI: >80
 IP: 65
 Ángulo Apertura: 360°
 Material: ABS+PC, anti UV
 Tiempo de Carga: 5 - 6 horas de luz solar directa
 Horas de Trabajo: Hasta 50 horas
 Altura Instalación: 2-3 metros
 Distancia instalación: ≤3 metros
 Batería Litio 18650, 3.7V, 3600mAh, 13.32Wh
 -07 Negro

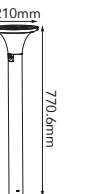
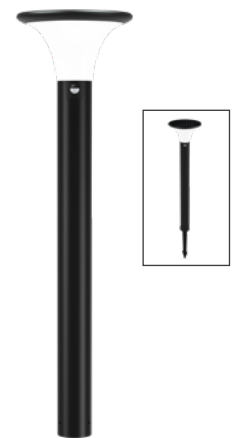

URBAN PRO



Sensor de Movimiento

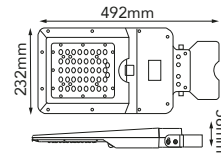

25-6215-*

Watts: 15W
 Lúmenes: 1600lm
 TC: 5000K
 CRI: >80
 IP: 65
 Ángulo Apertura: 140° * 70°
 Material: Aluminio
 Rango de Sensor PIR: 120°, < 3 - 8 metros
 Tiempo de Carga: 4 - 6 horas con luz solar directa
 Horas de Trabajo: Hasta 32 horas
 Altura Instalación: 2-4 metros
 Distancia Instalación: 8 a 12 metros entre luminarias
 Batería: LiFePO4, 32700, 12.8V, 6000mAh, 76.8Wh

07 Negro



Sensor de Movimiento

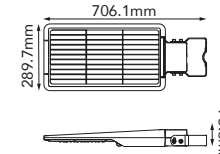

25-6240-*

Watts: 40W
 Lúmenes: 6000lm
 TC: 5000K
 CRI: >80
 IP: 65
 Ángulo Apertura: 140° * 70°
 Material: Aluminio
 Rango de Sensor PIR: 120°, < 8 - 12 metros
 Tiempo de Carga: 4 - 6 horas con luz solar directa
 Horas de Trabajo: Hasta 32 horas
 Altura Instalación: 3-6m
 Distancia Instalación: 10 a 15 metros entre luminarias
 Batería: LiFePO4, 32700, 12.8V, 6000mAh, 76.8Wh

07 Negro



Gran ángulo de apertura



Tiempo de Carga:
4 - 6 horas con luz solar directa



Tiempo de iluminación:
Hasta 32 horas

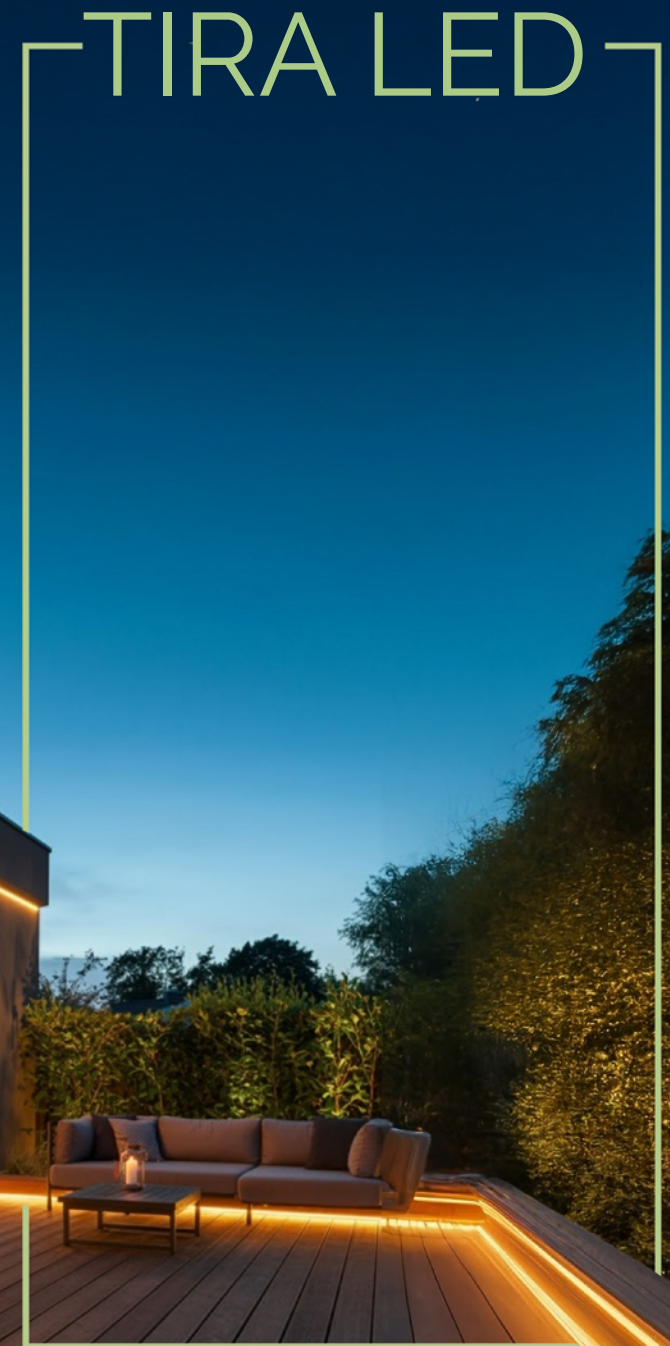

TIRA LED

MONOCROMÁTICAS

BAJO VOLTAJE INTERIORES

FB-72282-*

*2835 Top LED (0.2)W



Watts: 72W/5m - 14.4W/m
 Lúmenes: 1320lm/m
 TC: 3000K | 4000K
 Voltaje: 24V CD
 CRI: >80
 IP: 20
 Cantidad de LED: 60 LEDs/m
 Dimensiones: L5000 * W8 * H1.5mm
 Unidad / Corte: ✂ 10cm
 Humedad Relativa: 40% ~ 70%
 Temp. Ambiente: -20°C ~ 45°C

FB-43282-*

*2835 Top LED (0.2)W



Watts: 43.2W/5m - 8.64W/m
 Lúmenes: 780lm/m
 TC: 3000K | 4000K
 Voltaje: 24V CD
 CRI: >80
 IP: 20
 Cantidad de LED: 36 LEDs/m
 Dimensiones: L5000 * W8 * H1.5mm
 Unidad / Corte: ✂ 16.5cm
 Humedad Relativa: 40% ~ 70%
 Temp. Ambiente: -20°C ~ 45°C



3000K



4000K



3000K



4000K

Accesorios

*Se vende por separado



Fuente de poder a 24V

 FLS-2820
Conector Tira-Tira

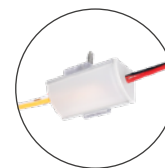
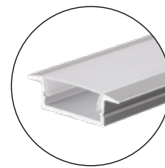
 FLS-2854-8mm
Conector Tira-Tira

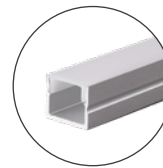
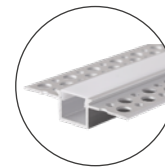
 AP-1616-2
Perfil 90°

 AP-2507-2
Perfil arco

 AP-2811-2
Perfil recto

 AP-1510-2
Perfil tira LED

 AP-2013-2
Perfil tira LED

MONOCROMÁTICAS

BAJO VOLTAJE EXTERIORES

FE-43287-*

*2835 Top LED (0.2)W



Watts: 43.2W/5m - 8.64W/m
 Lúmenes: 780lm/m
 TC: 3000K | 4000K
 Voltaje: 24V CD
 CRI: >80
 IP: 67
 Cantidad de LED: 36 LEDs/m
 Dimensiones: L5000 * W10 * H4mm
 Unidad / Corte: ✂ 16.5cm
 Humedad Relativa: 40% ~ 70%
 Temp. Ambiente: -20°C ~ 45°C

FE-72287-*

*2835 Top LED (0.2)W



Watts: 72W/5m - 14.4W/m
 Lúmenes: 1320lm/m
 TC: 3000K | 4000K
 Voltaje: 24V CD
 CRI: >80
 IP: 67
 Cantidad de LED: 60 LEDs/m
 Dimensiones: L5000 * W10 * H4mm
 Unidad / Corte: ✂ 10cm
 Humedad Relativa: 40% ~ 70%
 Temp. Ambiente: -20°C ~ 45°C



3000K



4000K



3000K



4000K

Accesorios

*Se vende por separado

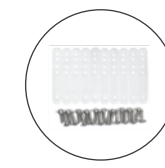

Fuente de poder a 24V

 CP-51800
10 Fajos de fijación y 20 tornillos

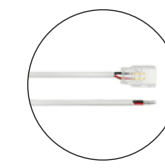
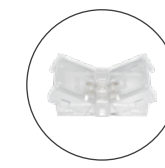
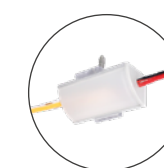
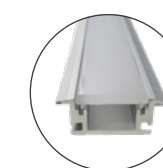
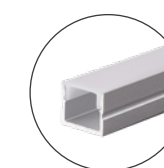
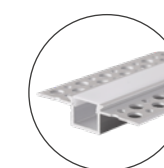
 WP-100
Pegamento

 F1-0110
Conector Tira-Cable

 F2-0210
Conector Tira-Tira

 AP-1616-2
Perfil 90°

 AP-2811-2
Perfil recto

 AP-1510-2
Perfil tira LED

 AP-2013-2
Perfil tira LED

MONOCROMÁTICAS

BAJO VOLTAJE EXTERIORES



FS-43285-*

*2835 Top LED (0.2)W



Watts: 43.2W/5m - 8.64W/m
 Lúmenes: 780lm/m
 TC: 3000K | 4000K
 Voltaje: 24V CD
 CRI: >80
 IP: 54
 Cantidad de LED: 36 LEDs/m
 Dimensiones: L5000 * W8 * H2.5mm
 Unidad / Corte: ✂ 16.5cm
 Humedad Relativa: 40% ~ 70%
 Temp. Ambiente: -20°C ~ 45°C



3000K



4000K

Accesorios

*Se vende por separado

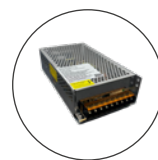

Fuente de poder a 24V

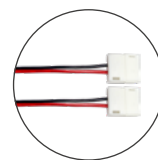

FLS-1054-8MM
Conector Tira-Cable-Tira

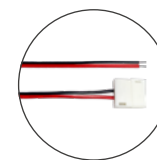

FLS-102B-Z
Conector Tira-Cable-Tira

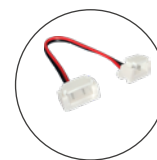

FLS-102-FD2
Conector Tira-Cable-Tira



FLS-102-C
Conector Tira-Tira



FLS-2854-8mm
Conector Tira-Tira

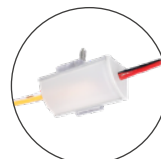

AP-1616-2
Perfil 90°

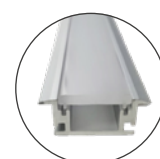

AP-2811-2
Perfil recto

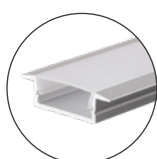

AP-2507-2
Perfil arco

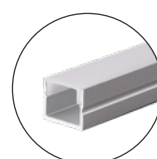

AP-1510-2
Perfil tira LED

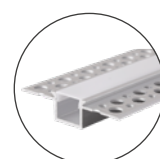

AP-2013-2
Perfil tira LED

CAMBIO CCT

BAJO VOLTAJE EXTERIORES



FS-48356-TC

*2016 Top LED (0.2)W



Watts: 48W/5m - 9.6W/m
 Lúmenes: 600lm/m
 TC: CCT Ajustable 2500K a 6000K
 Voltaje: 24V CD
 CRI: >80
 IP: 65
 Cantidad de LED: 120 LEDs/m
 Dimensiones: L5000 * W12 * H4mm
 Unidad / Corte: ✂ 10cm
 Humedad Relativa: 40% ~ 70%
 Temp. Ambiente: -20°C ~ 45°C



Tempertatura de Color ajustable

*Incluidos

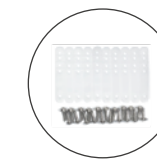

CP-51800
10 Fajos de fijación y 20 tornillos

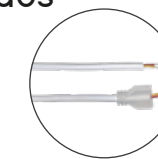

Cable de Conexión

Accesorios

*Se vende por separado



WP-100
Pegamento

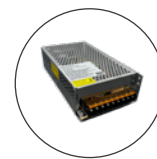

Fuente de poder a 24V



F4-5A
Receptor



M2+RGB-33A
Controlador



WIFI-106
Receptor

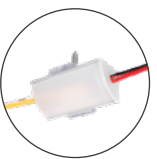

AP-1616-2
Perfil 90°

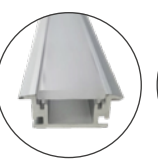

AP-2811-2
Perfil recto

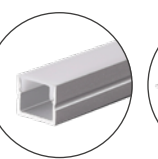

AP-1510-2
Perfil tira LED

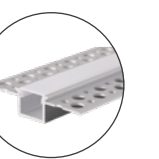

AP-2013-2
Perfil tira LED

RGB/RGBW

BAJO VOLTAJE EXTERIORES



FS-0036-RGB

*5050 Top LED

Watts: 43.2/5m - 8.6W/m
 TC: RGB
 Voltaje: 24V CD
 IP: 54
 Cantidad de LED: 36 LEDs/m
 Dimensiones: L5000 * W10 * H3mm
 Unidad / Corte: ✂ 16.5cm
 Humedad Relativa: 40% ~ 70%
 Temp. Ambiente: -20°C ~ 45°C



FS-96555-RGBW

*RGBW Top LED

Watts: 96W/5m - 19.2W/m
 TC: RGBW
 Voltaje: 24V CD
 IP: 54
 Dimensiones: L5000 * W12 * H3mm
 Unidad / Corte: ✂ 10cm
 Humedad Relativa: 40% ~ 70%
 Temp. Ambiente: -20°C ~ 45°C



Tempertatura de Color ajustable



Tempertatura de Color ajustable

Accesorios

*Se vende por separado



CP-51800 10 Fajos de fijación y 20 tornillos
 Fuente de poder a 24V
 WIFI-106 Receptor
 M8+M4-5A Controlador
 F4-5A Receptor
 AP-1616-2 Perfil 90°
 AP-2811-2 Perfil recto
 AP-1510-2 Perfil tira LED
 AP-2013-2 Perfil tira LED

FS-0036-RGB



FLS-103-D Conector Tira-Cable-Tira
 FLS-1054-10RGB Conector Tira-Cable-Tira
 FLS-2854-10RGB Conector Tira-Tira
 TR-1014 Conector Tira-Cable-Tira
 M6+RGB-33A Controlador

RUNNING STRIP



Caminadora SPI



FP-28119-*

Watts: 100W/10m - 10W/m
 Lúmenes: 800lm/m
 TC: 3000K | 4000K | 6000K
 Voltaje: 24V CD
 CRI: >80
 IP: 20
 Cantidad de LED: 120 LEDs / m
 Dimensiones: L10000*W9.5mm
 Unidad / Corte: ✂ 10cm
 Humedad Relativa: 40% ~ 70%
 Temp. Ambiente: -20°C ~ 45°C

*Rollo 10m, Con cinta autoadherible 3M



FR-20228

Control Remoto LED Monocromático LED

Voltaje: 5-24V CD
 Cantidad de Pixel: 3200PCS
 Modos: 26 Modos, Dimeable y 86 Standard



Conector Inicial y Receptor

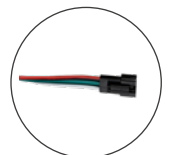

Conector Tira-Cable-Tira

*NOTA: Se vende por separado

Accesorios

*Se vende por separado

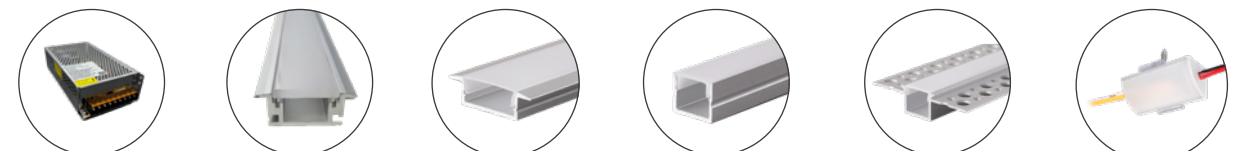

Fuente de poder a 24V
 AP-2811-2 Perfil recto
 AP-2507-2 Perfil arco
 AP-1510-2 Perfil tira LED
 AP-2013-2 Perfil tira LED
 AP-1616-2 Perfil 90°

PIXEL STRIP



FP-28186-RGB

LED COB

Watts:	12W/M 10 Pixeles/m
TC:	RGB PIXEL
Voltaje:	24V CD
CRI:	>80
IP:	20
Cantidad de LED:	60LEDS, 10 Pixles/M
Dimensiones:	L5000*W10mm
Unidad / Corte:	✂ 10cm
Humedad Relativa:	40% ~ 70%
Temp. Ambiente:	-20°C ~ 45°C

*Rollo 10m, Con cinta autoadherible 3M

Caminadora SPI



SP105E

Controlador Inteligente Bluetooth SPI

Voltaje:	5-24V CD
Corriente Máxima:	5.5A,
Cantidad de Pixel:	2048pcs
Modos:	200 modos incluidos
Puerto de Conexión:	PLUS+CLK+DATA+GND (3/4-PIN)
Canal RGB	

*Para SPI y DMX512

*NOTA: Se vende por separado



LT-CG-SPI

Controlador Inteligente Bluetooth SPI

Voltaje:	5-24V CD
Corriente Máxima:	5.5A,
Cantidad de Pixel:	2048pcs
Modos:	200 modos incluidos
Puerto de Conexión:	PLUS+CLK+DATA+GND (3/4-PIN)
Canal RGB	

*Para SPI y DMX512

*NOTA: Se vende por separado

Accesorios

*Se vende por separado

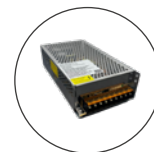

Fuente de poder a 24V

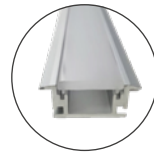

AP-2811-2 Perfil recto

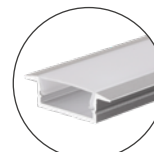

AP-2507-2 Perfil arco

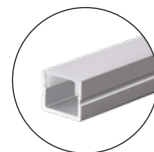

AP-1510-2 Perfil tira LED

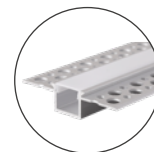

AP-2013-2 Perfil tira LED

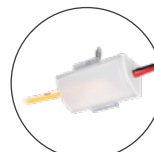

AP-1616-2 Perfil 90°

COB

BAJO VOLTAJE INTERIORES



FB-43528-*

LED COB

Watts:	500W/5m - 10W/m
Lúmenes:	1000lm/m
TC:	3000K 4000K
Voltaje:	24V CD
CRI:	>90
IP:	20
Ángulo Apertura:	145°
Cantidad de LED:	325 LEDs / m
Unidad / Corte:	✂ 4cm
Humedad Relativa:	40% ~ 70%
Temp. Ambiente:	-20°C ~ 45°C

*Rollo 5m, Con cinta autoadherible 3M



3000K



4000K

FB-43528-CCT

LED COB

Watts:	14W/m - 700W/50m
Lúmenes:	1350lm/m
TC:	CCT Ajustable 3000K -6500K
Voltaje:	24V CD
CRI:	>90
IP:	20
Ángulo Apertura:	145°
Cantidad de LED:	325 LEDs / m
Unidad / Corte:	✂ 4cm
Humedad Relativa:	40% ~ 70%
Temp. Ambiente:	-20°C ~ 45°C

*Rollo 50m, Con cinta autoadherible 3M



Tempertatura de Color ajustable

Accesorios

*Se vende por separado



F2B-0208 Conector Tira-Tira



F4B-2208 Tira-Cable-Tira



F3B-0218 Tira-Cable

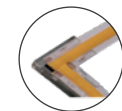

F5B-0228 Conector esquinero Tira-Tira

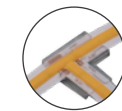

F6B-0238 Conector en T Tira-Tira



F2B-0208/CCT Conector Tira-Tira



F4B-2208/CCT Tira-Cable-Tira



F3B-0218/CCT Tira-Cable

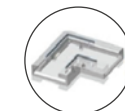

F5B-0228/CCT Conector en T Tira-Tira



Fuente de poder a 24V

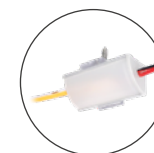

AP-1616-2 Perfil 90°

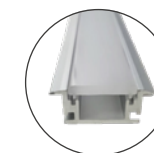

AP-2811-2 Perfil recto

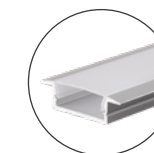

AP-2507-2 Perfil arco

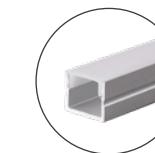

AP-1510-2 Perfil tira LED

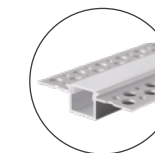

AP-2013-2 Perfil tira LED

SUMERGIBLES

BAJO VOLTAJE

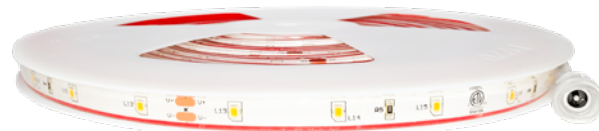

FC-43286-*

*2835 Top LED (0.2)W



Watts:	43.2W - 8.64W/m
Lúmenes:	544lm/m
TC:	3000K 4000K
Voltaje:	24V CD
Corriente:	1.8A (60mA por unidad)
IP:	68
Cantidad de LED:	180 LED s/m
Dimensiones:	L5000 * W10 * H4.5mm
Unidad / Corte:	✂ 6 LEDs 16.5cm
Humedad Relativa:	40% ~ 70%
Temp. Ambiente:	-20°C ~ 45°C



FS-1036-RGB

*5050 Top LED



Watts:	43.2W - 8.64W/m
Lúmenes:	RGB (Cambio de color)
Voltaje:	24V CD
Corriente:	2.4A (80mA por unidad)
IP:	68
Cantidad de LED:	300 LEDs (60LEDs/m)
Dimensiones:	L5000 * W12 * H4.5mm
Unidad / Corte:	✂ 6 LEDs / 16.5cm
Humedad Relativa:	40% ~ 70%
Temp. Ambiente:	-20°C ~ 45°C



3000K



4000K



Tempertatura de Color ajustable

Accesorios

Incluidos



CP-51800
10 Fajos de fijación
y 20 tornillos



2 Mangas
termorretráctiles



Conector inicial

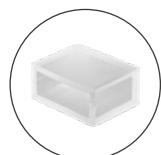

Tapa final

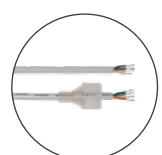

TR-1014
Conector
Tira-Cable-Tira

Accesorios

*Se vende por separado



Fuente de
poder a 24V



WP-100
Pegamento

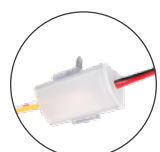

AP-1616-2
Perfil 90°



AP-2811-2
Perfil recto

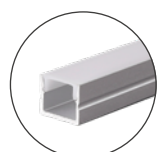

AP-1510-2
Perfil tira LED

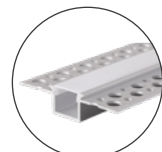

AP-2013-2
Perfil tira LED

TIRAS DIRECTAS A 127V

DE FÁCIL INSTALACIÓN



NEON 127V



*Cubierta transparente

FS-27140-CL



Watts: 450W/50m - 9W/M
 Lúmenes: 850lm/m
 TC: 3000K | 4000K
 Voltaje: 127V CD
 CRI: >80
 IP: 67
 Cantidad de LED: 608 LEDs/m
 Unidad / Corte: ✂ 25cm
 Humedad Relativa: 40% ~ 70%
 Temp. Ambiente: -20°C ~ 45°C

*Rollo 50m, Con cinta autoadherible 3M.

*Se recomienda no hacer cortes de menos de 3m



3000K



4000K



*Cubierta opalina

FS-27140-*



Watts: 450W/50m - 9W/M
 Lúmenes: 700lm/m
 Voltaje: 127V CD
 IP: 67
 Cantidad de LED: 608 LEDs/m
 Dimensiones: L5000 * W12 * H3mm
 Unidad / Corte: ✂ 25cm
 Humedad Relativa: 40% ~ 70%
 Temp. Ambiente: -20°C ~ 45°C

COLORES



CW 6500K



NW 4000K



WW 3000K



RD Rojo



GR Verde



PR Púrpura



YE Amarillo Oro



BL Azul



IB Azul Hielo

Accesorios

*Se vende por separado



SET-27140
Set de conexión



CP-27140
Clip de montaje



EC-27140
Tapa final

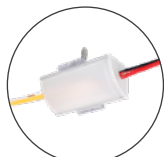

AP-1616
Perfil 90°



Dimeable con sistemas
LTECH

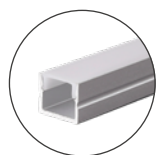

AP-1510-2
Perfil tira LED



AP-2811-2
Perfil recto

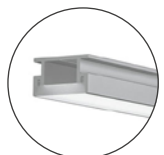

AP-2011-2
Perfil tira LED

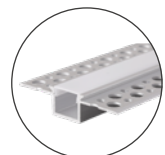

AP-2013-2
Perfil tira LED

FÁCIL INSTALACIÓN

NO REQUIERE DRIVER



FV-27286-*

Watts: 600W/50m - 12W/m
 Lúmenes: 1100lm/m
 TC: 3000K | 4000K
 Voltaje: 127V AC
 CRI: >80
 IP: 20
 Cantidad de LED: 120 LEDs/m
 Dimensiones: L50000 * W10 * H6mm
 Unidad / Corte: ✂ 4.5cm
 Humedad Relativa: 40% ~ 70%
 Temp. Ambiente: -20°C ~ 45°C

*Rollo 50m, Con cinta autoadherible 3M.

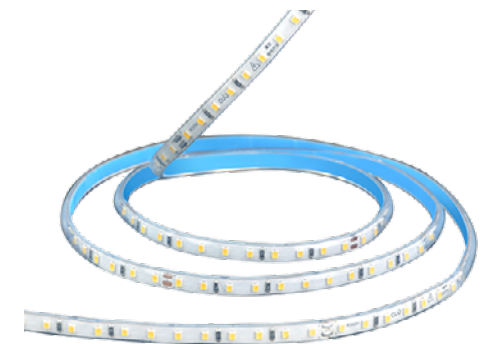

FV-48120-*

Watts: 400W/50m - 8W/m
 Lúmenes: 900lm/m
 TC: 3000K | 4000K
 Voltaje: 127V AC
 CRI: >80
 IP: 20
 Cantidad de LED: 120 LEDs/m
 Dimensiones: L50000 * W6 * H3mm
 Unidad / Corte: ✂ 10cm
 Humedad Relativa: 40% ~ 70%
 Temp. Ambiente: -20°C ~ 45°C

*Rollo 50m, Con cinta autoadherible 3M.

Accesorios

*Se vende por separado

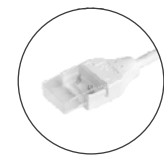

C1F-27286
Conector inicial tira

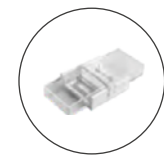

C2M-27286
Conector intermedio sin soldadura para tira LED



C3L-27286
Conector en L sin soldadura para tira LED



C4S-27286
Línea de conexión con soldadura



EC-27286
Tapa final para tira LED

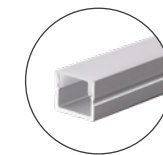

AP-1510-2
Perfil tira LED

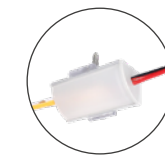

AP-1616-2
Perfil 90°

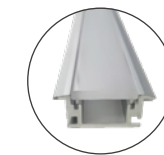

AP-2811-2
Perfil recto

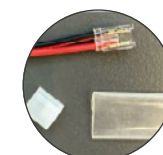

CON-48120
Conector inicial, manga termocontractil y tapa final

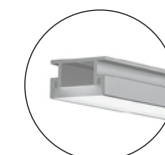

AP-2011-2
Perfil tira LED

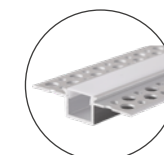

AP-2013-2
Perfil tira LED

¡ADVERTENCIA!

RIESGO DE ELECTROSHOCK EN CASO DE ENTRAR EN CONTACTO CON EL AGUA

FÁCIL INSTALACIÓN DE FÁCIL INSTALACIÓN



FV-48110-*

*2835 Top

Watts: 480W/50m - 9.6W/m
 Lúmenes: 615lm/m
 TC: 3000K
 Voltaje: 110V
 CRI: >80
 IP: 65
 Cantidad de LED: 60 LEDs / m
 Dimensiones: L50000 * W11 * H7mm
 Unidad / Corte: ✂ 50cm
 Humedad Relativa: 40% ~ 70%
 Temp. Ambiente: -20°C ~ 45°C

*Rollo 50m

*Se vende por metro o al comprar rollo, incluye kit de instalación: SET-48110



3000K



4000K



FS-27352-*

*2835 Top

Watts: 180W/50m - 3.6W/m
 Lúmenes: 260lm/m
 TC: 6000K
 Voltaje: 110V
 CRI: >80
 IP: 44
 Cantidad de LED: 36 LEDs/m
 Dimensiones: L50000 * W110 * H75mm
 Unidad / Corte: ✂ 50cm
 Humedad Relativa: 40% ~ 70%
 Temp. Ambiente: -20°C ~ 45°C

*Rollo 50m

*Se vende por metro o al comprar rollo, incluye kit de instalación: SET-48110



6000K

Accesorios

*Se vende por separado



SET-48110
Kit de instalación

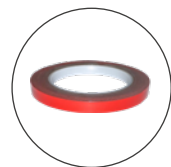

AT-2011
Cinta doble cara



CP-27352
Clip de Sujeción



EC-27352
Tapa final



WP-100
Pegamento

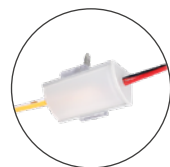

AP-1616-2
Perfil 90°

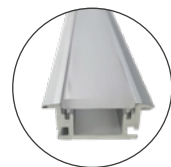

AP-2811-2
Perfil recto

Materiales:

1. Perfil de aluminio 6063 con aleación de óxido en la superficie
2. Difusor de PC opalino
3. Grapa de plásticos o acero inoxidable



AP-1616-2-* -12 Aluminio



TAP-1616
Par de tapas finales



CLIP-1616
Par de grapas y tornillos

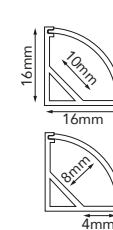

AP-2011-2-* -07 Negro -12 Aluminio

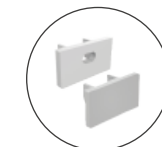

Par de tapas finales

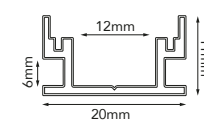

AP-2013-2-* -12 Aluminio

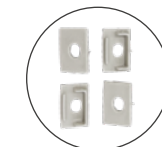

4 de tapas finales

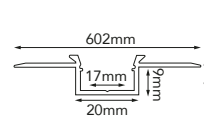

PERFILES



AP-2811-2-* -12 Aluminio



TAP-2811
Par de tapas finales

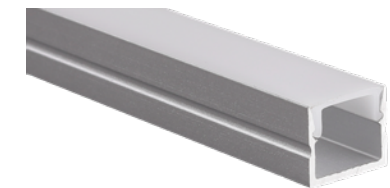
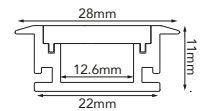

AP-1510-2-* -12 Aluminio

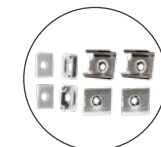

4 de tapas y 4 clips

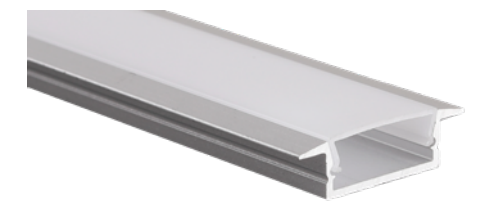
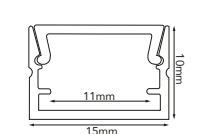

AP-2507-2-* -07 Negro -12 Aluminio



4 de tapas y 4 clips

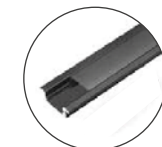

ACR-2507-2/07
Acrílico Negro disponible para perfil

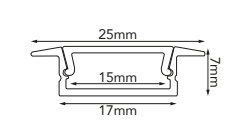

*NOTA: Accesorios incluidos. NO se venden por separado

*Incluidos *Se vende por separado

CONECTORES IP68

CONECTORES PARA EXTERIOR

Diseñados para resistir las condiciones del entorno, estos conectores permiten realizar instalaciones profesionales, seguras y duraderas en exteriores.



LCH-1312-68-3P
Conector de tipo lineal



LCH-1312-68-4P
Conector de tipo lineal



LCH-1165-68-T3PA
Conector de tipo lineal



LCH-1165-68-T5P
Conector de tipo lineal
5 Polos



Fuente de Poder	PS-12025
Poder de Carga	25W
Voltaje de Entrada	90-137 V CA
Voltaje de Salida	12V CD
Temp. de Operación	-20°~60°C / 20%~90%
Dimensiones	L85 x W58 x H38mm
Protección	IP20 Uso Interior



Fuente de Poder	PS-12050	PS-24050
Poder de Carga	50W	
Voltaje de Entrada	90-137 V CA	
Voltaje de Salida	12V CD	24V CD
Temp. de Operación	-20°~60°C / 20%~90%	
Dimensiones	L110 x W78 x H35mm	
Protección	IP20 Uso Interior	



Fuente de Poder	PS-12100	PS-24100
Poder de Carga	100W	
Voltaje de Entrada	90-137 V CA	
Voltaje de Salida	12V CD	24V CD
Temp. de Operación	-20°~60°C / 20%~90%	
Dimensiones	L159 x W97 x H38mm	
Protección	IP20 Uso Interior	

*NOTA: Para un óptimo funcionamiento, se recomienda utilizar únicamente el 80% de la potencia

FUENTES DE PODER



Fuente de Poder	PS-12150	PS-24150
Poder de Carga	150W	
Voltaje de Entrada	90-137 V CA	
Voltaje de Salida	12V CD	24V CD
Temp. de Operación	-20°~60°C / 20%~90%	
Dimensiones	L199 x W98 x H42mm	
Protección	IP20 Uso Interior	



Fuente de Poder	PS-12250	PS-24250
Poder de Carga	250W	
Voltaje de Entrada	90-137 V CA (Cambio con Switch)	
Voltaje de Salida	12V CD	24V CD
Temp. de Operación	-20°~60°C / 20%~90%	
Dimensiones	L200 x W110 x H50mm	
Protección	IP20 Uso Interior	



Fuente de Poder	PS-24400
Poder de Carga	400W
Voltaje de Entrada	90-137 V CA
Voltaje de Salida	24V CD
Temp. de Operación	-20°~60°C / 20%~90%
Dimensiones	L215 x W115 x H50mm
Protección	IP20 Uso Interior

FUENTES DE PODER



DIMEABLES. TRIAC/0-10V



Fuente de Poder	PS-12100-D	PS-24100-D
Poder de Carga	100W	
Voltaje de Entrada	127 V	
Voltaje de Salida	12V / 6.6A	24V
Temp. de Operación	-20°~60°C / 20%~90%	
Dimensiones	L148 x W48 x H25mm	
Protección	IP20 Uso Interior	



Fuente de Poder	PS-12150-D	PS-24150-D
Poder de Carga	150W	
Voltaje de Entrada	127 V	
Voltaje de Salida	12V / 12.5A	24V
Temp. de Operación	-20°~60°C / 20%~90%	
Dimensiones	L210 x W48 x H25mm	
Protección	IP20 Uso Interior	



Fuente de Poder	PS-12250-D	PS-24250-D
Poder de Carga	250W	
Voltaje de Entrada	127 V	
Voltaje de Salida	12V / 20.8A	24V
Temp. de Operación	-20°~60°C / 20%~90%	
Dimensiones	L226 x W62 x H27mm	
Protección	IP20 Uso Interior	

*NOTA: Para un óptimo funcionamiento, se recomienda utilizar únicamente el 80% de la potencia

*NOTA: Para un óptimo funcionamiento, se recomienda utilizar únicamente el 80% de la potencia

TRANSFORMADORES



Transformador	TRA-0812
Poder de Carga	Máx. 8W
Voltaje	127 V CA
Operación	CONUS
Protección	IP65



Transformador	TRA-1250
Poder de Carga	Máx. 50W
Voltaje de Entrada	127 V CA
Voltaje de Salida	12V CA para foco MR16
Protección	IP65



Transformador	TRA-12100	TRA-24100
Poder de Carga	100W	
Voltaje de Entrada	90-137 V CA	
Voltaje de Salida	12V CD / 8.5A	24V CD / 4.2A
Frecuencia	47~63Hz	
Temp. de Operación	-20°~60°C / 20%~90% HR	
Dimensiones	L207 x W66 x H44mm	
Protección	IP67	



Transformador	TRA-1245
Poder de Carga	Máx. 45W
Voltaje de Entrada	90-137 V CA
Voltaje de Salida	12V CD
Temp. de Operación	-20°~60°C / 20%~90%
Dimensiones	L160 x W52 x H32mm
Protección	IP67



Transformador	TRA-2430
Poder de Carga	30W
Voltaje de Entrada	90-137 V CA
Voltaje de Salida	24V CD / 2.5A
Frecuencia	47~63Hz
Temp. de Operación	-20°~60°C / 20%~90% HR
Dimensiones	L222 x W30 x H20mm
Protección	IP67



Transformador	TRA-12200	TRA-24200
Poder de Carga	200W	
Voltaje de Entrada	90-137 V CA	
Voltaje de Salida	12V CD / 16.5A	24V CD / 8.3A
Frecuencia	47~63Hz	
Temp. de Operación	-10°~60°C / 20%~90% HR	
Dimensiones	L225 x W120 x H55mm	
Protección	IP67	



Transformador	TRA-2460
Poder de Carga	Máx. 60W
Voltaje de Entrada	90-137 V CA
Voltaje de Salida	24V CD
Frecuencia	47~63Hz
Temp. de Operación	-20°~60°C / 20%~90% HR
Dimensiones	L175 x W72 x H45mm
Protección	IP67

*NOTA: Para un óptimo funcionamiento, se recomienda utilizar únicamente el 80% de la potencia

*NOTA: Para un óptimo funcionamiento, se recomienda utilizar únicamente el 80% de la potencia

**+20 años dedicados a la
iluminación arquitectónica**

Estamos comprometidos en ofrecer soluciones lumínicas de vanguardia que transforman los espacios en ambientes de bienestar y confort.

astro[®]
LED Lighting

Para más información visita:

 www.astroled.com.mx

 Facebook: [astroledlighting](https://www.facebook.com/astroledlighting)

 Instagram: [astroledlighting](https://www.instagram.com/astroledlighting)

\$100 MXN